

# PORCELAIN PAVERS COLLECTION

Volume 1

16, 20 & 30MM THICKNESSES



♥  
Love for Stone

## PORCELAIN PAVERS COLLECTION

**16mm**



**20mm**

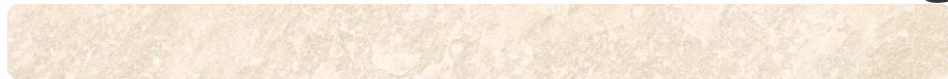

**30mm**



## Thicknesses

Unfold a perfect amalgamation of functionality and durability with outdoor tiles that come in a range of thicknesses including 16mm, 20mm, and 30mm, offering versatility for various landscaping and architectural applications.

The 16mm thickness is ideal for lighter pedestrian areas while the 20mm option provides durability for moderate foot traffic and vehicular loads. For heavy-duty outdoor spaces such as driveways or commercial areas, the 30mm thickness offers

robustness and resilience against high impact and weight-bearing requirements. Look no further for a seamless transformation of the outdoors as you discover a seamless option with the Porcelain Pavers Collection by Our.

**Versatile  
Durable  
Functional**

BENEFITS OF  
PORCELAIN  
PAVERS

>

INDEX

>

PRODUCT  
RANGE

>

ACCESSORIES

>

TECHNICAL  
SPECIFICATIONS

>

# Sizes Board

Introducing our exclusive collection of outdoor tiles, designed for versatility and style. Available in a range of sizes to suit any exterior style, from expansive patios to cozy balconies. Elevate your outdoor space with unmatched durability and timeless elegance.

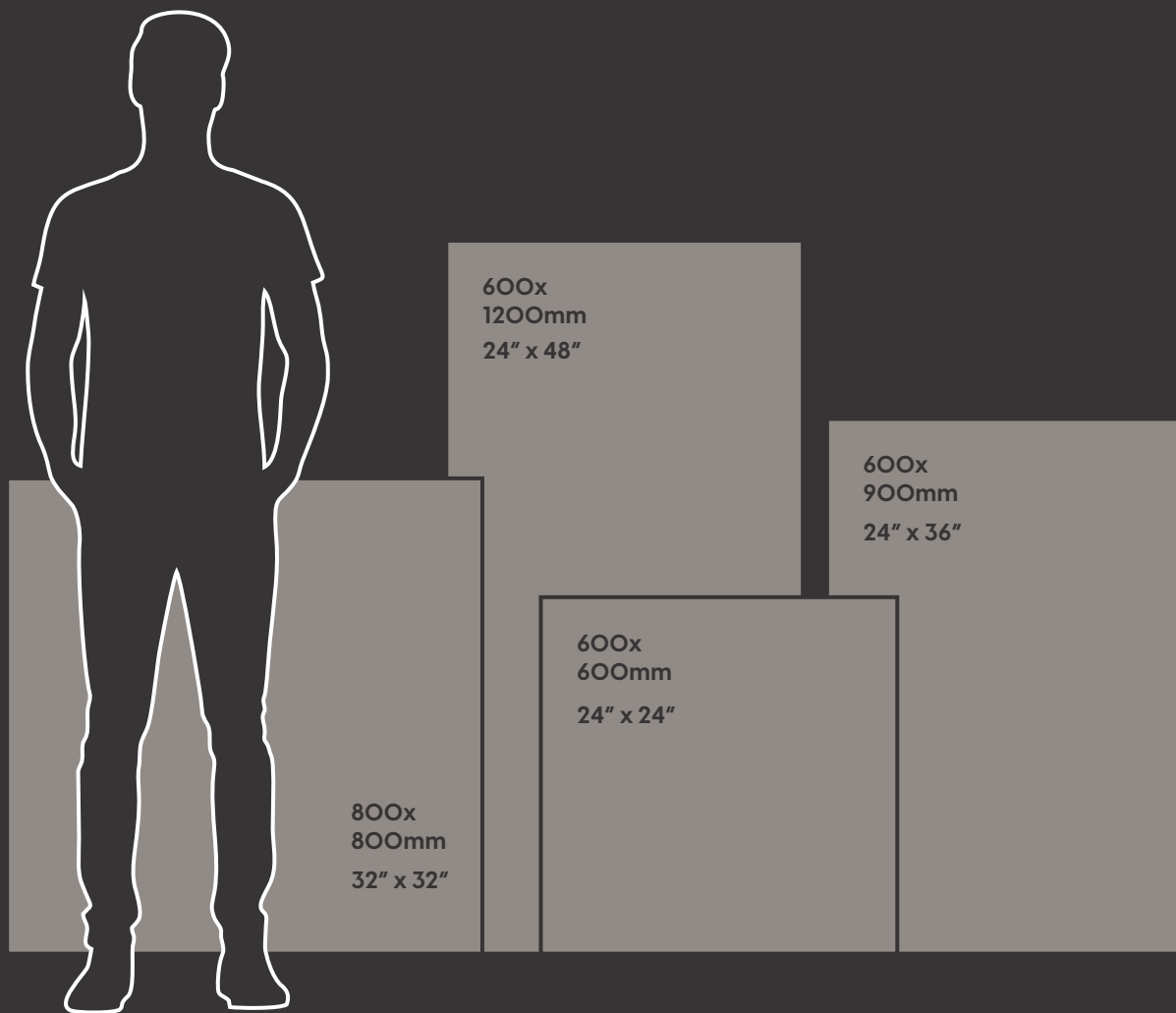

## Architectural Colors

### OUTDOOR PORCELAIN PAVERS

Add a strong yet subtle personality to your outdoors with simple yet significant earthy colors that reflect the architectural elements. The timeless earthy color palette infuses the outdoors with solidity and durability.

The natural accent details create a visual interest when laid on outdoors, adding a contrasting elegance. These magnificent surfaces reflect the natural beauty and architectural elements very well.



# Earthy Vibrance

## Why choose Porcelain Pavers for your outdoor area?



**Non-Slip  
(R11) Surface**



**Frost Resistant**



**Does Not  
Absorb Water**



**D.I.Y. (Easy to Do it  
Yourself at Home)**



**Easy to Clean**



**Salt Resistant**



**Anti Bacterial**



**Resistant to  
Chemical Products**



**Fire Resistant**



**Resistant to  
Breaking Loads**



**Resists Sudden  
Temperature Changes**



**Easy to Install**



**Moss and Mould  
Resistant**



**Easy to Inspect  
and Replace**



**Impact  
Resistant**



**Resistant to  
Abrasion**



**Resistant to  
Staining**



**Resistant to  
Blemishes**



**Resistant to  
Deep Scratches**



**Sunlight-Resistant  
Colours**



**Safe from  
Thermal Shock**



**Durable**



**Acid Resistant**

BENEFITS OF  
PORCELAIN  
PAVERS

>

INDEX

>

PRODUCT  
RANGE

>

ACCESSORIES

>

TECHNICAL  
SPECIFICATIONS

>



# Index

## PRODUCT RANGE

MAGMA  
LAVA  
EARTHSTONE  
ROCK  
LIMESTONE  
CRYSTAL  
FOSSIL  
HAMMER STONE  
MUSTANG  
SAND  
QUARTZITE  
EVEREST  
SLATES  
GRANITES  
SMOKE  
SANDSTONES  
BELGIUM  
BLUESTONE  
MARBLE  
WOOD PLANKS

## ACCESSORIES

COBBLES  
STEP-RISER  
EDGING  
COPING  
POOL DRAINS

## TECHNICAL SPECIFICATIONS

BENEFITS OF  
PORCELAIN  
PAVERS

>

INDEX

>

PRODUCT  
RANGE

>

ACCESSORIES

>

TECHNICAL  
SPECIFICATIONS

>

# Product Range



## Magma Series

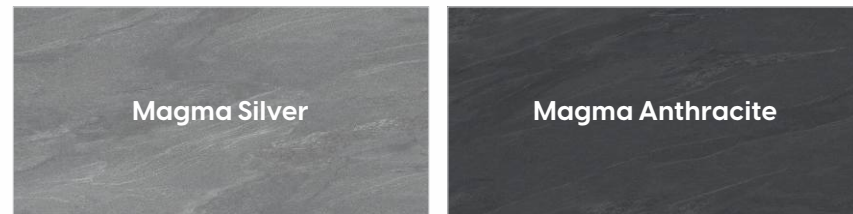

## Lava Series

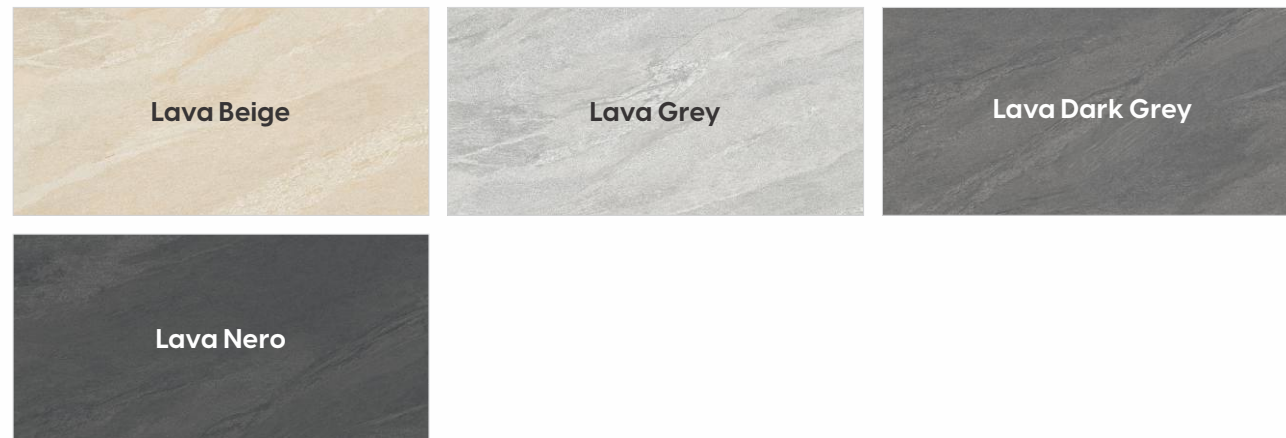

## Earthstone Series

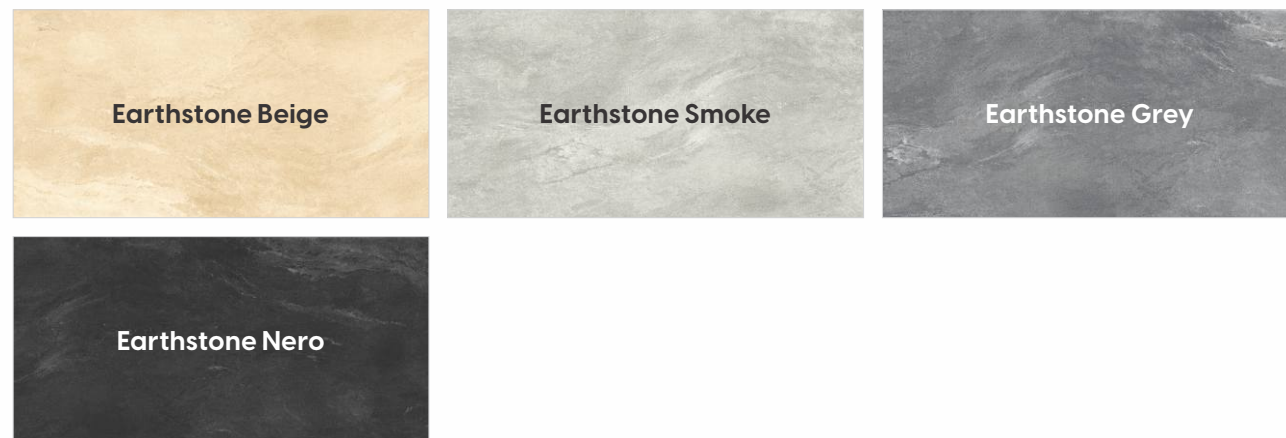

## Rock Series

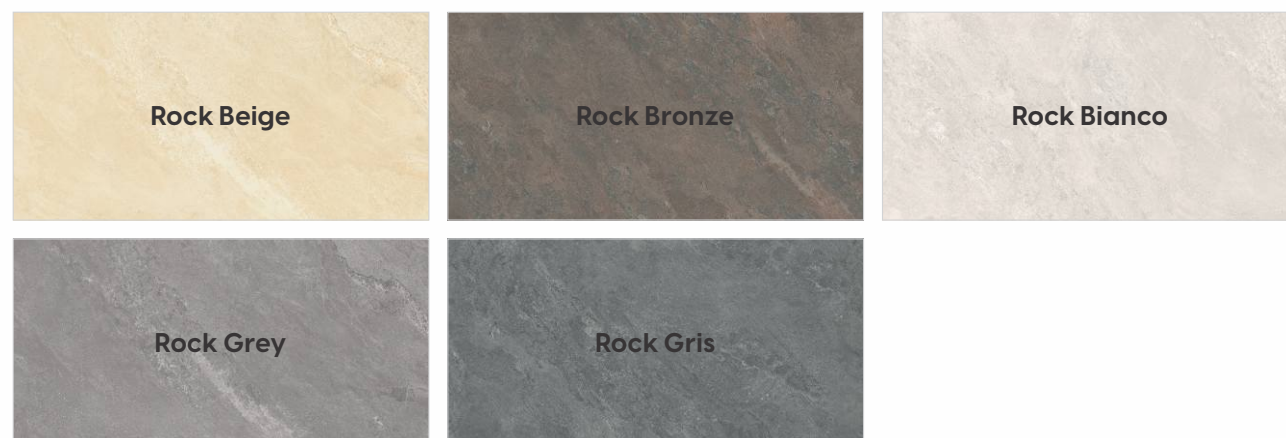

## Limestone Series

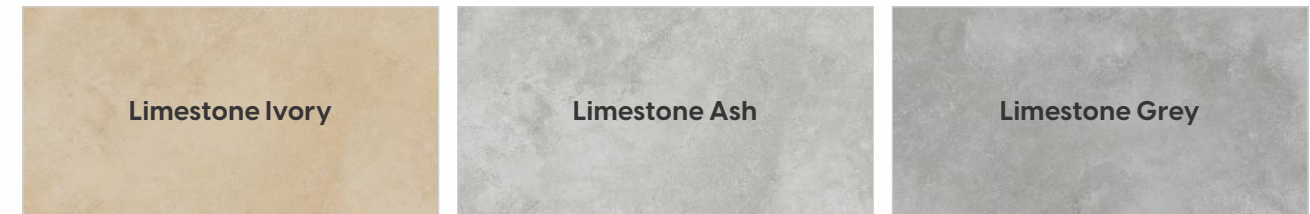

## Crystal Series

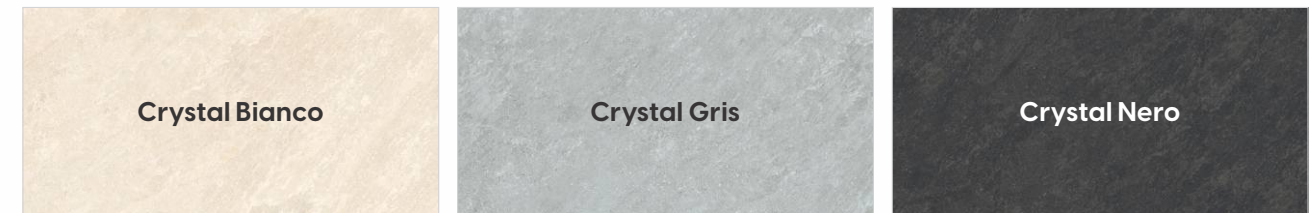

## Fossil Series



## Hammer Stone Series

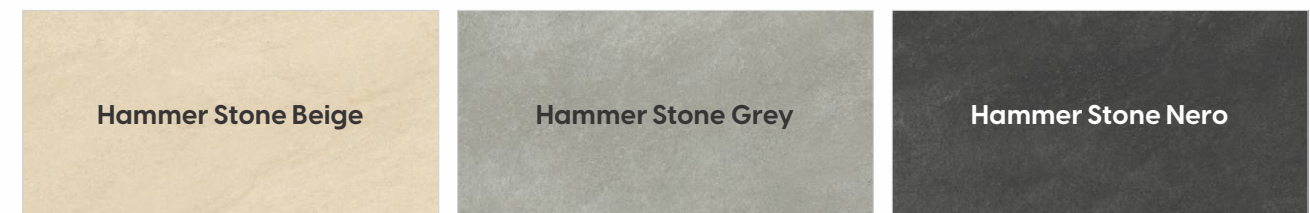

## Mustang Series

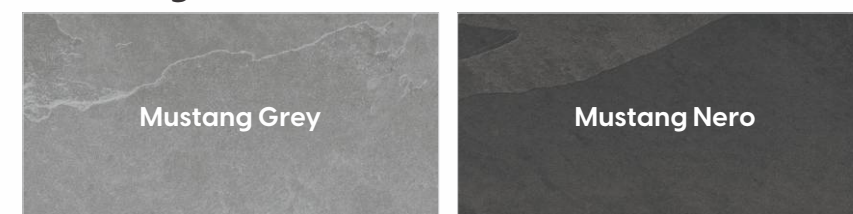

BENEFITS OF  
PORCELAIN  
PAVERS

>

INDEX

>

PRODUCT  
RANGE

>

ACCESSORIES

>

TECHNICAL  
SPECIFICATIONS

>

# Product Range



## Sand Series

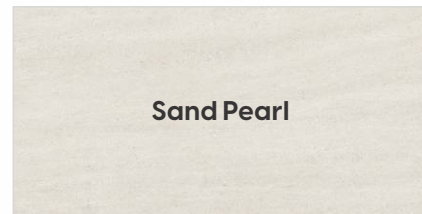

Sand Pearl



Sand Mocha

## Quartzite Series

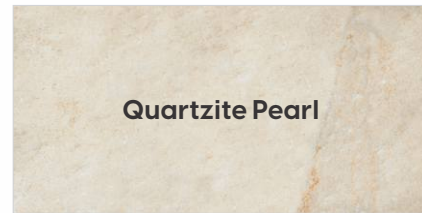

Quartzite Pearl

## Everest Series

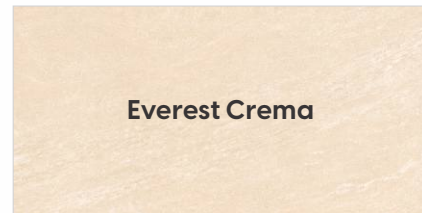

Everest Crema



Everest Pearl



Everest Gris

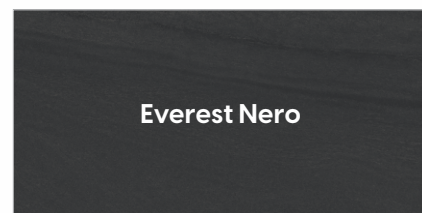

Everest Nero

## Slates Series



African Slate

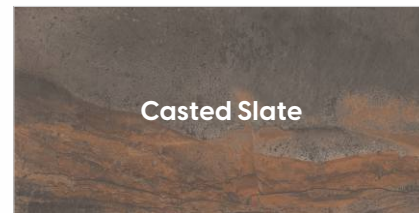

Casted Slate

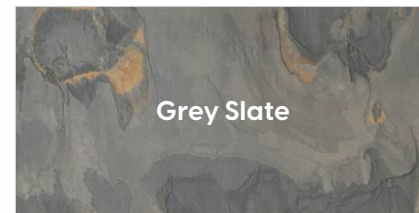

Grey Slate



Copper Slate

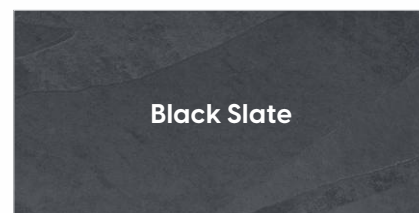

Black Slate

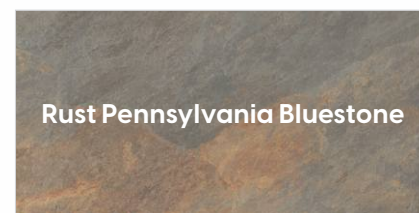

Rust Pennsylvania Bluestone

## Granites Series



G-603



G-654



Basalt

## Smoke Series



Smoke Beige



Smoke Taupe



Smoke Taupe

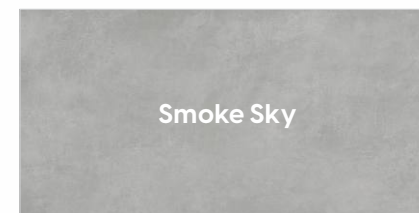

Smoke Sky



Smoke Grey

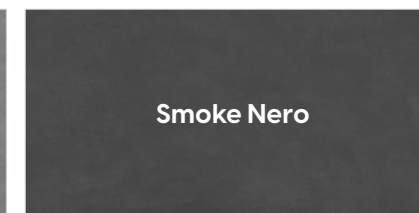

Smoke Nero

## Sandstones Series

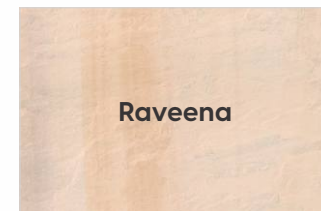

Raveena

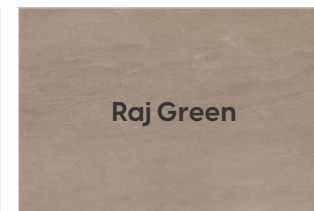

Raj Green

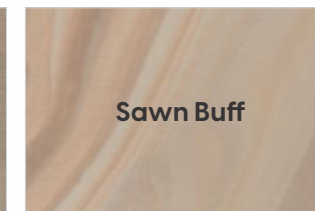

Sawn Buff

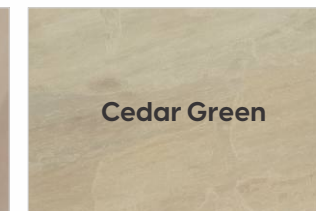

Cedar Green

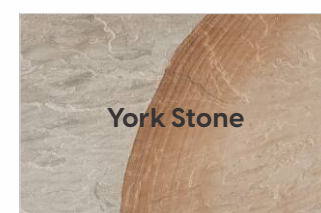

York Stone

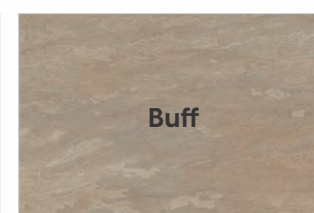

Buff

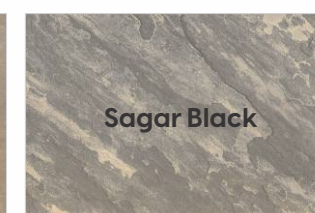

Sagar Black



Kandla Grey

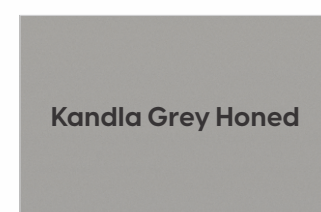

Kandla Grey Honed

BENEFITS OF  
PORCELAIN  
PAVERS

>

INDEX

>

PRODUCT  
RANGE

>

ACCESSORIES

>

TECHNICAL  
SPECIFICATIONS

>

# Product Range



## Belgium Series



## Bluestone Series

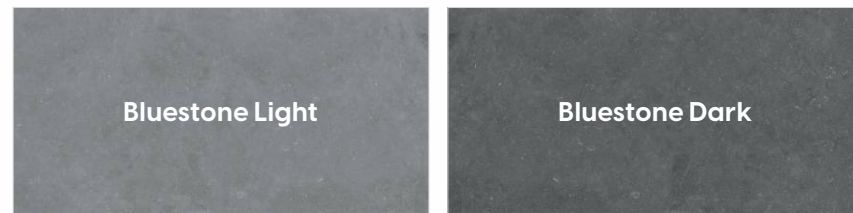

## Marble Series



## Wood Plank Series

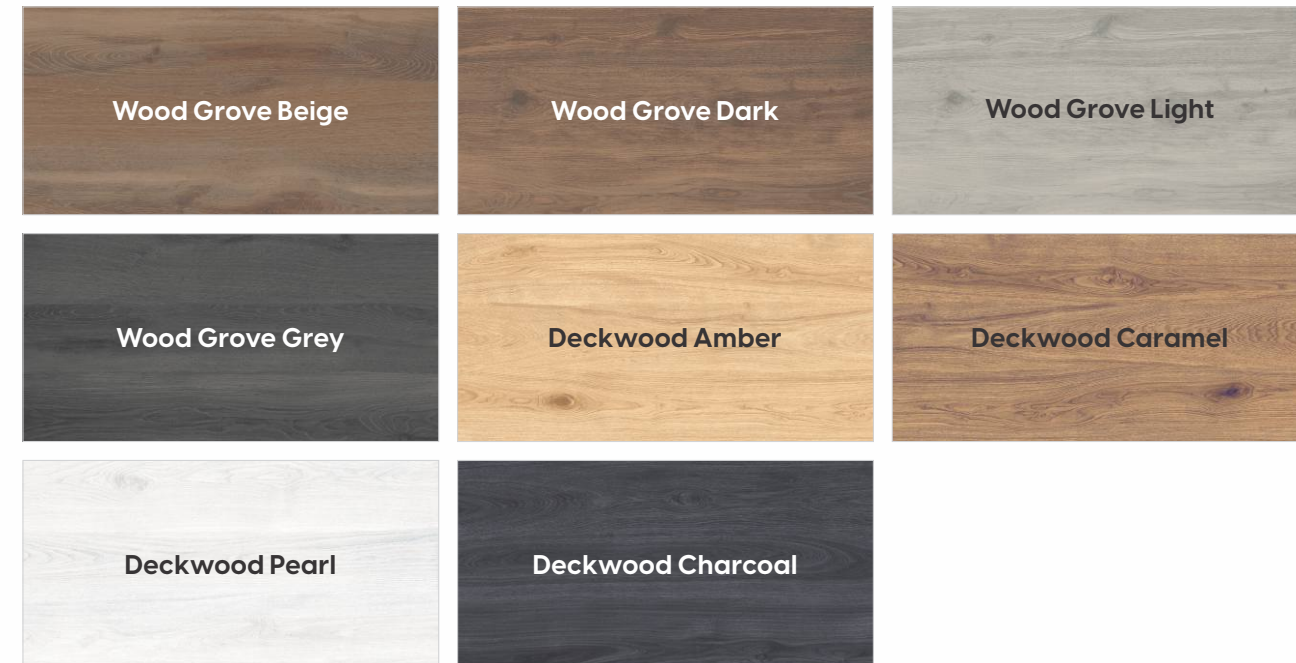

## Accessories

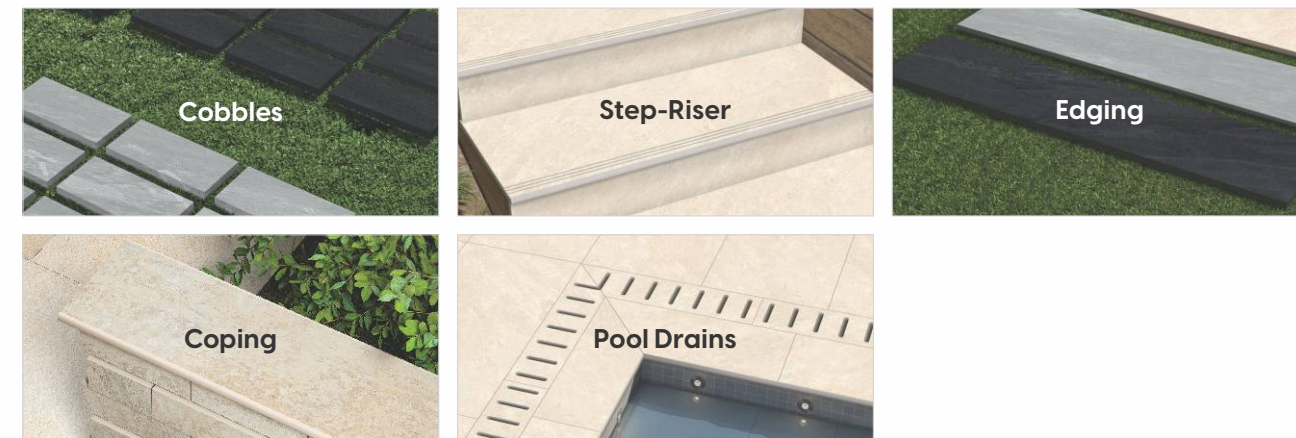

BENEFITS OF  
PORCELAIN  
PAVERS

>

INDEX

>

PRODUCT  
RANGE

>

ACCESSORIES

>

TECHNICAL  
SPECIFICATIONS

>

# Magma Series

OUTDOOR PORCELAIN PAVERS

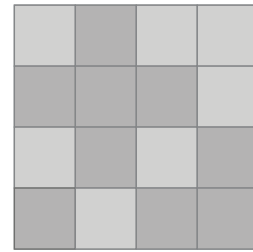

V2



R11

SURFACE

Sizes Available :



600x  
1200mm

Random : 5



600x  
900mm

Random : 10



800x  
800mm

Random : 6



600x  
600mm

Random : 10

Thickness

16mm

20mm

30mm



DIY



FROST  
RESISTANCE



STAIN  
RESISTANCE



7221

Magma Silver

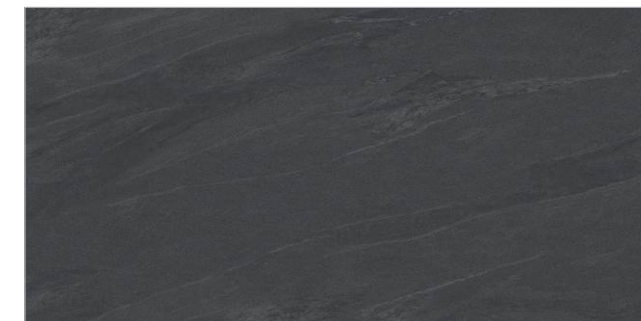

7224 Magma Anthracite

BENEFITS OF  
PORCELAIN  
PAVERS

>

INDEX

>

PRODUCT  
RANGE

>

ACCESSORIES

>

TECHNICAL  
SPECIFICATIONS

>



Preview of : **Magma Silver**

BENEFITS OF  
PORCELAIN  
PAVERS

>

INDEX

>

PRODUCT  
RANGE

>

ACCESSORIES

>

TECHNICAL  
SPECIFICATIONS

>



Preview of : **Magma Anthracite**

BENEFITS OF  
PORCELAIN  
PAVERS

>

INDEX

>

PRODUCT  
RANGE

>

ACCESSORIES

>

TECHNICAL  
SPECIFICATIONS

>

# Lava Series

OUTDOOR PORCELAIN PAVERS

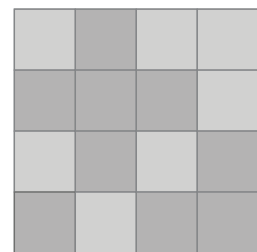

V2



**R11**  
SURFACE

Sizes Available :



**600x  
1200mm**

Random : 5



**600x  
900mm**

Random : 9



**800x  
800mm**

Random : 5



**600x  
600mm**

Random : 16

Thickness

16mm

20mm

30mm



DIY



FROST  
RESISTANCE



STAIN  
RESISTANCE



1071

Lava Beige

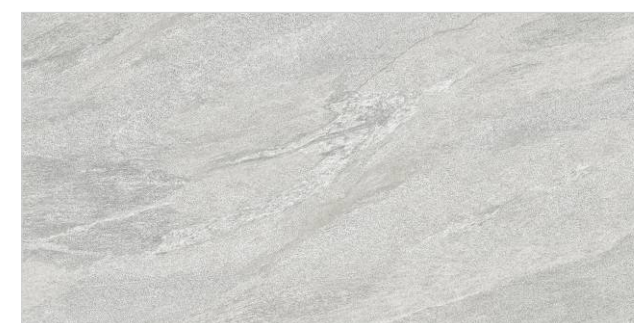

1068

Lava Grey



1044

Lava Dark Grey

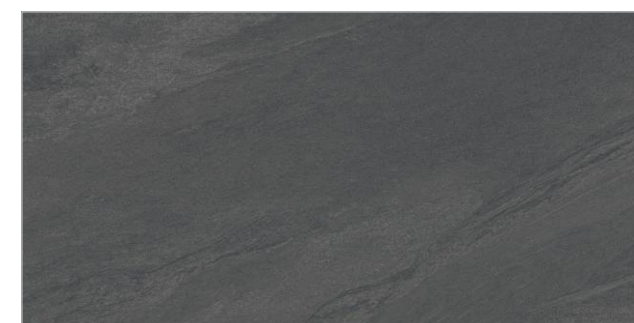

1100

Lava Nero

BENEFITS OF  
PORCELAIN  
PAVERS

>

INDEX

>

PRODUCT  
RANGE

>

ACCESSORIES

>

TECHNICAL  
SPECIFICATIONS

>



Preview of : **Lava Beige**

BENEFITS OF  
PORCELAIN  
PAVERS

>

INDEX

>

PRODUCT  
RANGE

>

ACCESSORIES

>

TECHNICAL  
SPECIFICATIONS

>



Preview of : **Lava Grey**

BENEFITS OF  
PORCELAIN  
PAVERS

>

INDEX

>

PRODUCT  
RANGE

>

ACCESSORIES

>

TECHNICAL  
SPECIFICATIONS

>



Preview of : **Lava Dark Grey**

BENEFITS OF  
PORCELAIN  
PAVERS

>

INDEX

>

PRODUCT  
RANGE

>

ACCESSORIES

>

TECHNICAL  
SPECIFICATIONS

>

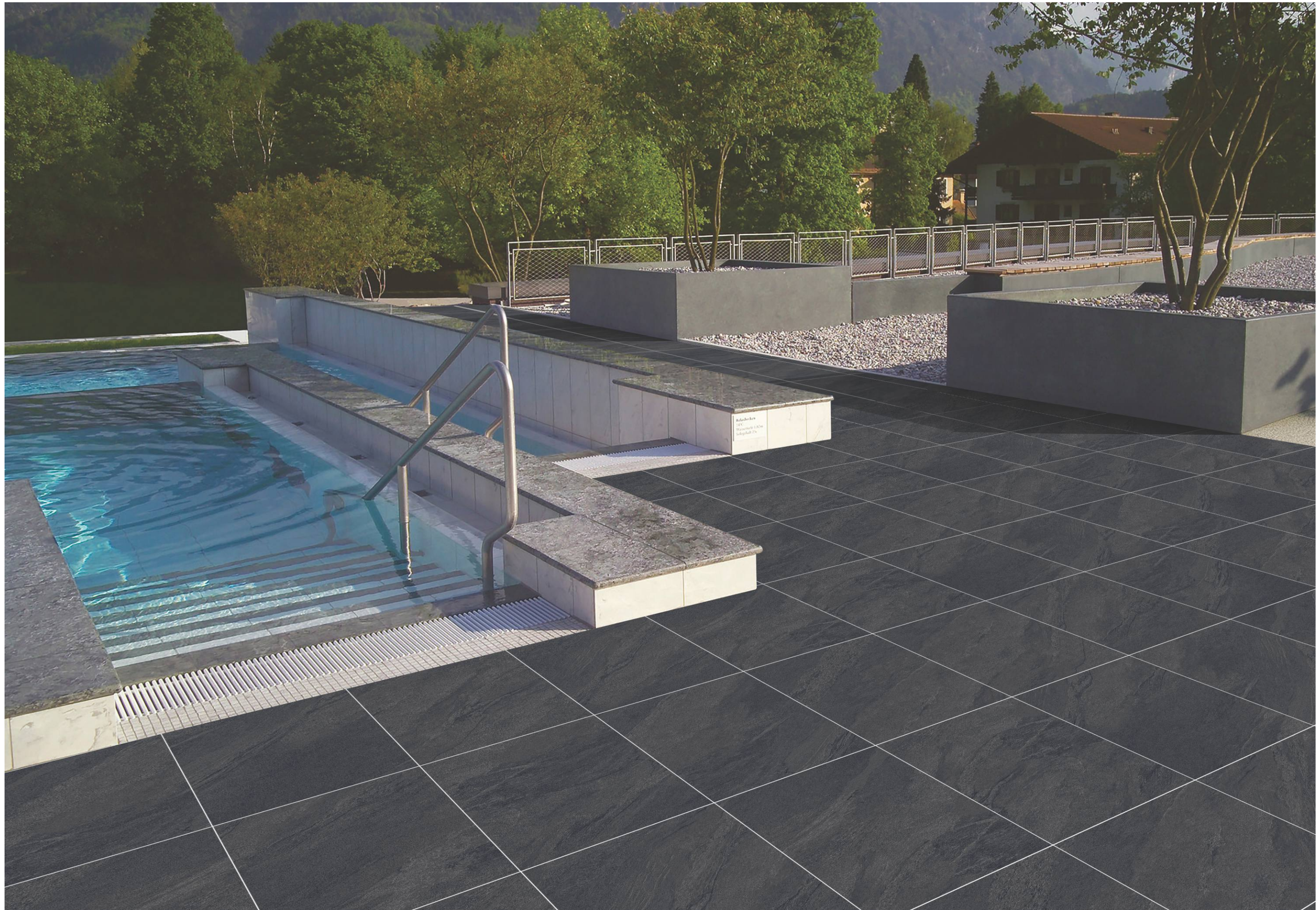

Preview of : **Lava Nero**

BENEFITS OF  
PORCELAIN  
PAVERS

>

INDEX

>

PRODUCT  
RANGE

>

ACCESSORIES

>

TECHNICAL  
SPECIFICATIONS

>

# Earthstone Series

OUTDOOR PORCELAIN PAVERS

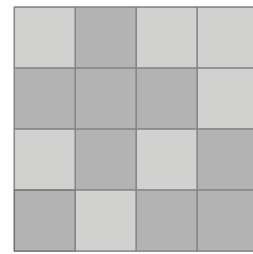

V2



R11

SURFACE

Sizes Available :



600x  
1200mm

Random : 3



600x  
900mm

Random : 4



800x  
800mm

Random : 4



600x  
600mm

Random : 5

Thickness

16mm

20mm

30mm



DIY



FROST  
RESISTANCE



STAIN  
RESISTANCE



7204 Earthstone Beige



7206 Earthstone Smoke



7203 Earthstone Grey



7202 Earthstone Nero

BENEFITS OF  
PORCELAIN  
PAVERS

>

INDEX

>

PRODUCT  
RANGE

>

ACCESSORIES

>

TECHNICAL  
SPECIFICATIONS

>



Preview of : **Earthstone Beige**

BENEFITS OF  
PORCELAIN  
PAVERS

>

INDEX

>

PRODUCT  
RANGE

>

ACCESSORIES

>

TECHNICAL  
SPECIFICATIONS

>



Preview of : **Earthstone Smoke**

BENEFITS OF  
PORCELAIN  
PAVERS

>

INDEX

>

PRODUCT  
RANGE

>

ACCESSORIES

>

TECHNICAL  
SPECIFICATIONS

>



Preview of : **Earthstone Grey**

BENEFITS OF  
PORCELAIN  
PAVERS

>

INDEX

>

PRODUCT  
RANGE

>

ACCESSORIES

>

TECHNICAL  
SPECIFICATIONS

>



Preview of : **Earthstone Nero**

BENEFITS OF  
PORCELAIN  
PAVERS

>

INDEX

>

PRODUCT  
RANGE

>

ACCESSORIES

>

TECHNICAL  
SPECIFICATIONS

>

# Rock Series

OUTDOOR PORCELAIN PAVERS

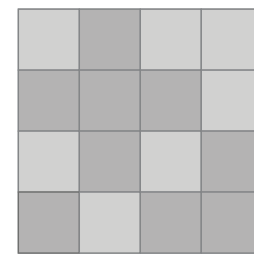

V2



**R11**  
SURFACE

Sizes Available :



**600x  
1200mm**

Random : 3



**600x  
900mm**

Random : 6



**800x  
800mm**

Random : 4



**600x  
600mm**

Random : 8

Thickness

16mm

20mm

30mm



DIY



FROST  
RESISTANCE



STAIN  
RESISTANCE



**4508**

**Rock Beige**



**4506**

**Rock Bronze**



**4502**

**Rock Bianco**



**4512**

**Rock Grey**



**4503**

**Rock Gris**

BENEFITS OF  
PORCELAIN  
PAVERS

>

INDEX

>

PRODUCT  
RANGE

>

ACCESSORIES

>

TECHNICAL  
SPECIFICATIONS

>



Preview of : **Rock Beige**

BENEFITS OF  
PORCELAIN  
PAVERS

>

INDEX

>

PRODUCT  
RANGE

>

ACCESSORIES

>

TECHNICAL  
SPECIFICATIONS

>



Preview of : **Rock Bronze**

BENEFITS OF  
PORCELAIN  
PAVERS

>

INDEX

>

PRODUCT  
RANGE

>

ACCESSORIES

>

TECHNICAL  
SPECIFICATIONS

>



Preview of : **Rock Bianco**

BENEFITS OF  
PORCELAIN  
PAVERS

>

INDEX

>

PRODUCT  
RANGE

>

ACCESSORIES

>

TECHNICAL  
SPECIFICATIONS

>



Preview of : **Rock Grey**

BENEFITS OF  
PORCELAIN  
PAVERS

>

INDEX

>

PRODUCT  
RANGE

>

ACCESSORIES

>

TECHNICAL  
SPECIFICATIONS

>



Preview of : **Rock Gris**

BENEFITS OF  
PORCELAIN  
PAVERS

>

INDEX

>

PRODUCT  
RANGE

>

ACCESSORIES

>

TECHNICAL  
SPECIFICATIONS

>

# Limestone Series

OUTDOOR PORCELAIN PAVERS

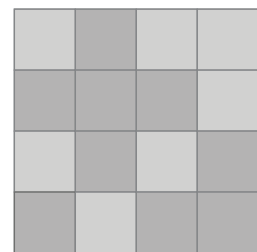

V2



**R11**

SURFACE

Sizes Available :



**600x  
1200mm**

Random : 5



**600x  
900mm**

Random : 5



**800x  
800mm**

Random : 4



**600x  
600mm**

Random : 7

Thickness

**16mm**

**20mm**

**30mm**



DIY



FROST  
RESISTANCE



STAIN  
RESISTANCE



**4517 Limestone Ivory**



**4520 Limestone Ash**

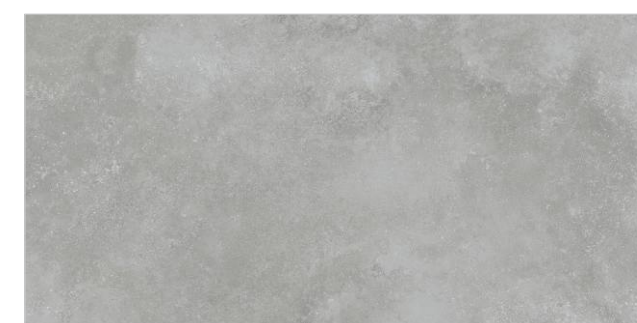

**4518 Limestone Grey**

BENEFITS OF  
PORCELAIN  
PAVERS

>

INDEX

>

PRODUCT  
RANGE

>

ACCESSORIES

>

TECHNICAL  
SPECIFICATIONS

>



Preview of : **Limestone Ivory**

BENEFITS OF  
PORCELAIN  
PAVERS

>

INDEX

>

PRODUCT  
RANGE

>

ACCESSORIES

>

TECHNICAL  
SPECIFICATIONS

>



Preview of : **Limestone Ash**

BENEFITS OF  
PORCELAIN  
PAVERS

>

INDEX

>

PRODUCT  
RANGE

>

ACCESSORIES

>

TECHNICAL  
SPECIFICATIONS

>



Preview of : **Limestone Grey**

BENEFITS OF  
PORCELAIN  
PAVERS

>

INDEX

>

PRODUCT  
RANGE

>

ACCESSORIES

>

TECHNICAL  
SPECIFICATIONS

>

# Crystal Series

OUTDOOR PORCELAIN PAVERS

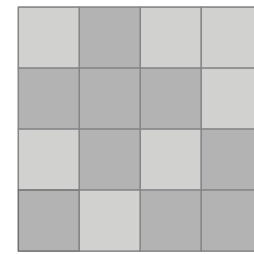

V2



R11

SURFACE

Sizes Available :



600x  
1200mm

Random : 3



600x  
900mm

Random : 4



800x  
800mm

Random : 3



600x  
600mm

Random : 5

Thickness

16mm

20mm

30mm



DIY



FROST  
RESISTANCE



STAIN  
RESISTANCE



1001 Crystal Bianco



1002 Crystal Gris

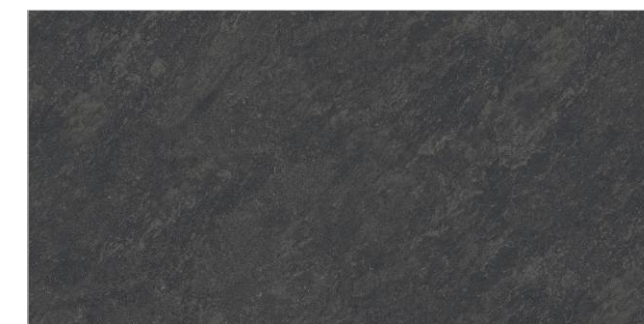

1221 Crystal Nero

BENEFITS OF  
PORCELAIN  
PAVERS

>

INDEX

>

PRODUCT  
RANGE

>

ACCESSORIES

>

TECHNICAL  
SPECIFICATIONS

>



Preview of : **Crystal Bianco**

BENEFITS OF  
PORCELAIN  
PAVERS

>

INDEX

>

PRODUCT  
RANGE

>

ACCESSORIES

>

TECHNICAL  
SPECIFICATIONS

>



Preview of : **Crystal Gris**

BENEFITS OF  
PORCELAIN  
PAVERS

>

INDEX

>

PRODUCT  
RANGE

>

ACCESSORIES

>

TECHNICAL  
SPECIFICATIONS

>



Preview of : **Crystal Nero**

BENEFITS OF  
PORCELAIN  
PAVERS

>

INDEX

>

PRODUCT  
RANGE

>

ACCESSORIES

>

TECHNICAL  
SPECIFICATIONS

>

# Fossil Series

OUTDOOR PORCELAIN PAVERS

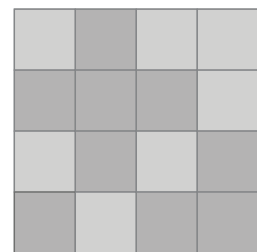

V2



**R11**

SURFACE

Sizes Available :



**600x  
1200mm**

Random : 10



**600x  
900mm**

Random : 9



**800x  
800mm**

Random : 20



**600x  
600mm**

Random : 24

Thickness

16mm

20mm

30mm



DIY



FROST  
RESISTANCE



STAIN  
RESISTANCE

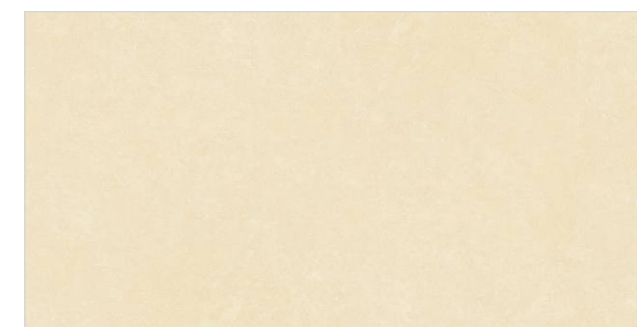

**4523**

**Fossil Beige**



**4521**

**Fossil Gris**



**4525**

**Fossil Sky**

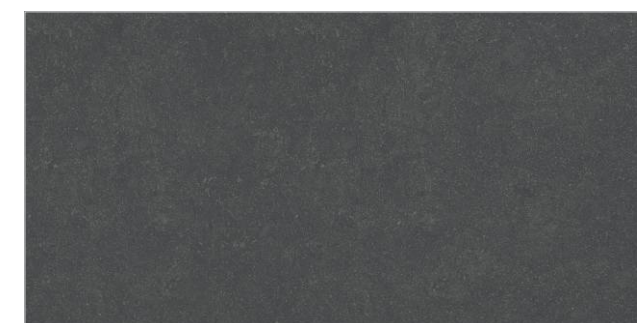

**4522**

**Fossil Nero**

BENEFITS OF  
PORCELAIN  
PAVERS

>

INDEX

>

PRODUCT  
RANGE

>

ACCESSORIES

>

TECHNICAL  
SPECIFICATIONS

>



Preview of : **Fossil Beige**

BENEFITS OF  
PORCELAIN  
PAVERS

>

INDEX

>

PRODUCT  
RANGE

>

ACCESSORIES

>

TECHNICAL  
SPECIFICATIONS

>



BENEFITS OF  
PORCELAIN  
PAVERS

>

INDEX

>

PRODUCT  
RANGE

>

ACCESSORIES

>

TECHNICAL  
SPECIFICATIONS

>

Preview of : **Fossil Gris**



BENEFITS OF  
PORCELAIN  
PAVERS

>

INDEX

>

PRODUCT  
RANGE

>

ACCESSORIES

>

TECHNICAL  
SPECIFICATIONS

>

Preview of : **Fossil Sky**



Preview of : **Fossil Nero**

BENEFITS OF  
PORCELAIN  
PAVERS

>

INDEX

>

PRODUCT  
RANGE

>

ACCESSORIES

>

TECHNICAL  
SPECIFICATIONS

>

# Hammer Stone Series

OUTDOOR PORCELAIN PAVERS

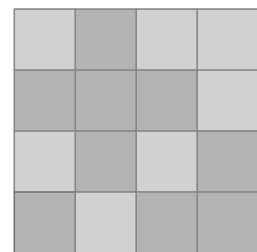

V2



Sizes Available :



**600x  
1200mm**  
Random : 3



**600x  
900mm**  
Random : 3



**800x  
800mm**  
Random : 5



**600x  
600mm**  
Random : 5

Thickness

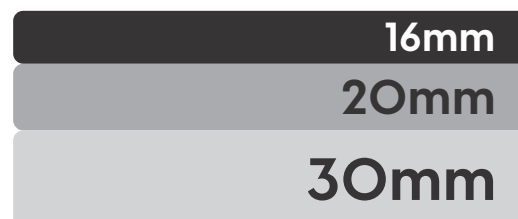

DIY



FROST  
RESISTANCE



STAIN  
RESISTANCE

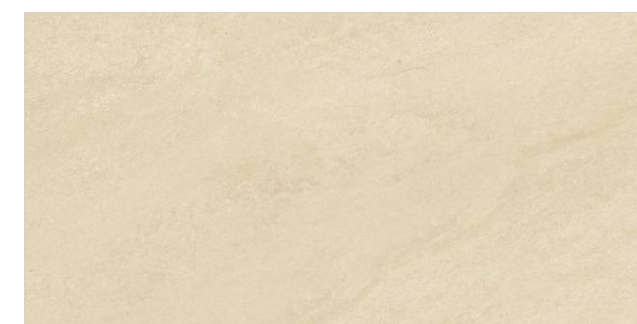

**1021 Hammer Stone  
Beige**



**1022 Hammer Stone  
Grey**

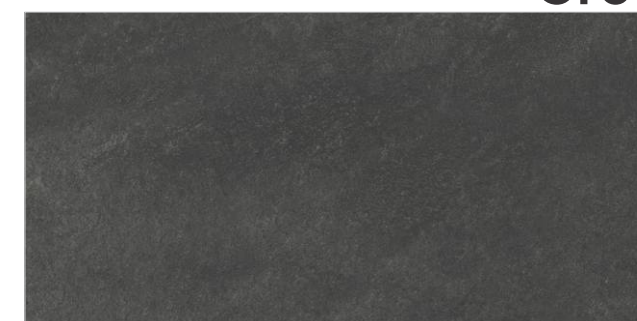

**1023 Hammer Stone  
Nero**

BENEFITS OF  
PORCELAIN  
PAVERS

>

INDEX

>

PRODUCT  
RANGE

>

ACCESSORIES

>

TECHNICAL  
SPECIFICATIONS

>



Preview of : **Hammer Stone Beige**

BENEFITS OF  
PORCELAIN  
PAVERS

>

INDEX

>

PRODUCT  
RANGE

>

ACCESSORIES

>

TECHNICAL  
SPECIFICATIONS

>



Preview of : **Hammer Stone Grey**

BENEFITS OF  
PORCELAIN  
PAVERS

>

INDEX

>

PRODUCT  
RANGE

>

ACCESSORIES

>

TECHNICAL  
SPECIFICATIONS

>



Preview of : **Hammer Stone Nero**

BENEFITS OF  
PORCELAIN  
PAVERS

>

INDEX

>

PRODUCT  
RANGE

>

ACCESSORIES

>

TECHNICAL  
SPECIFICATIONS

>

# Mustang Series

OUTDOOR PORCELAIN PAVERS

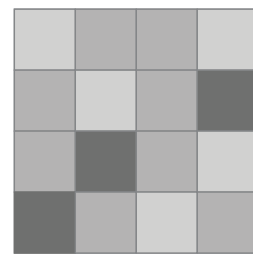

V3



R11

SURFACE

Sizes Available :

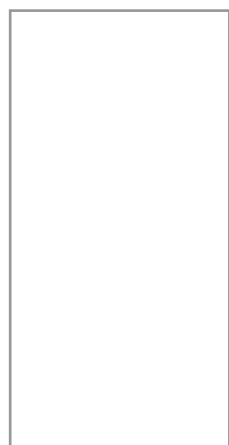

600x  
1200mm

Random : 4



600x  
900mm

Random : 8



800x  
800mm

Random : 8



600x  
600mm

Random : 8

Thickness

16mm

20mm

30mm



DIY



FROST  
RESISTANCE



STAIN  
RESISTANCE

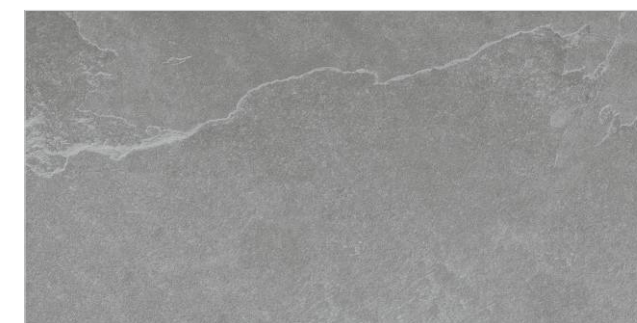

1015

Mustang Grey

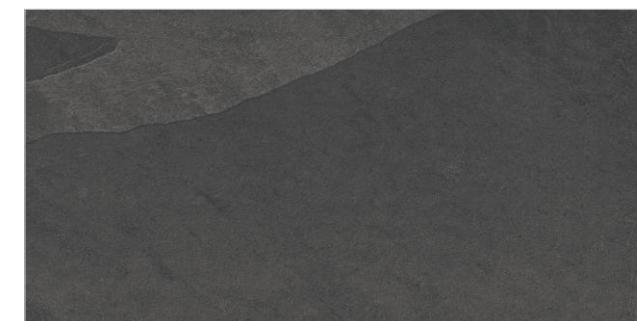

1014

Mustang Nero

BENEFITS OF  
PORCELAIN  
PAVERS

>

INDEX

>

PRODUCT  
RANGE

>

ACCESSORIES

>

TECHNICAL  
SPECIFICATIONS

>



Preview of : **Mustang Grey**

BENEFITS OF  
PORCELAIN  
PAVERS

>

INDEX

>

PRODUCT  
RANGE

>

ACCESSORIES

>

TECHNICAL  
SPECIFICATIONS

>



Preview of : **Mustang Nero**

BENEFITS OF  
PORCELAIN  
PAVERS

>

INDEX

>

PRODUCT  
RANGE

>

ACCESSORIES

>

TECHNICAL  
SPECIFICATIONS

>

# Sand Series

OUTDOOR PORCELAIN PAVERS

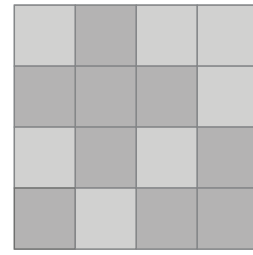

V2



**R11**

SURFACE

Sizes Available :



**600x  
1200mm**

Random : 1



**600x  
900mm**

Random : 2



**800x  
800mm**

Random : 3



**600x  
600mm**

Random : 3

Thickness

16mm

20mm

30mm



DIY



FROST  
RESISTANCE



STAIN  
RESISTANCE



**1006**

**Sand Pearl**



**1005**

**Sand Mocha**

BENEFITS OF  
PORCELAIN  
PAVERS

>

INDEX

>

PRODUCT  
RANGE

>

ACCESSORIES

>

TECHNICAL  
SPECIFICATIONS

>



Preview of : **Sand Pearl**

BENEFITS OF  
PORCELAIN  
PAVERS

>

INDEX

>

PRODUCT  
RANGE

>

ACCESSORIES

>

TECHNICAL  
SPECIFICATIONS

>



Preview of : **Sand Mocha**

BENEFITS OF  
PORCELAIN  
PAVERS

>

INDEX

>

PRODUCT  
RANGE

>

ACCESSORIES

>

TECHNICAL  
SPECIFICATIONS

>

# Quartzite Series

OUTDOOR PORCELAIN PAVERS

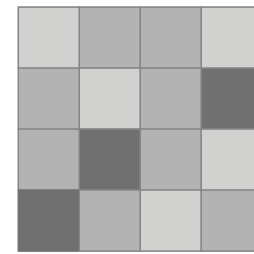

V3



**R11**  
SURFACE

Sizes Available :



**600x  
1200mm**

Random :14



**600x  
900mm**

Random : 14



**800x  
800mm**

Random : 14



**600x  
600mm**

Random : 30

Thickness

16mm

20mm

30mm



DIY



FROST  
RESISTANCE



STAIN  
RESISTANCE



1011

Quartzite Pearl

BENEFITS OF  
PORCELAIN  
PAVERS

>

INDEX

>

PRODUCT  
RANGE

>

ACCESSORIES

>

TECHNICAL  
SPECIFICATIONS

>



Preview of : **Quartzite Pearl**

BENEFITS OF  
PORCELAIN  
PAVERS

>

INDEX

>

PRODUCT  
RANGE

>

ACCESSORIES

>

TECHNICAL  
SPECIFICATIONS

>

# Everest Series

OUTDOOR PORCELAIN PAVERS

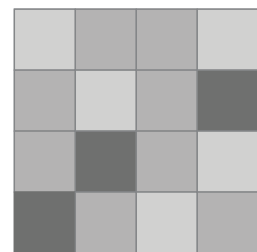

V3



R11

SURFACE

Sizes Available :



600x  
1200mm

Random : 5



600x  
900mm

Random : 5



800x  
800mm

Random : 10



600x  
600mm

Random : 10

Thickness

16mm

20mm

30mm



DIY



FROST  
RESISTANCE



STAIN  
RESISTANCE



1252

Everest Crema



1251

Everest Pearl



1253

Everest Gris

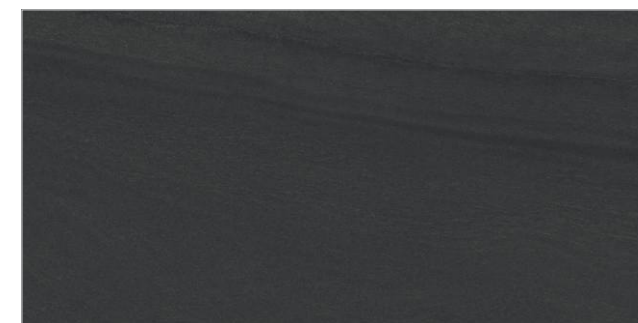

1254

Everest Nero

BENEFITS OF  
PORCELAIN  
PAVERS

>

INDEX

>

PRODUCT  
RANGE

>

ACCESSORIES

>

TECHNICAL  
SPECIFICATIONS

>



Preview of : **Everest Crema**

BENEFITS OF  
PORCELAIN  
PAVERS

>

INDEX

>

PRODUCT  
RANGE

>

ACCESSORIES

>

TECHNICAL  
SPECIFICATIONS

>



Preview of : **Everest Pearl**

BENEFITS OF  
PORCELAIN  
PAVERS

>

INDEX

>

PRODUCT  
RANGE

>

ACCESSORIES

>

TECHNICAL  
SPECIFICATIONS

>



Preview of : **Everest Gris**

BENEFITS OF  
PORCELAIN  
PAVERS

>

INDEX

>

PRODUCT  
RANGE

>

ACCESSORIES

>

TECHNICAL  
SPECIFICATIONS

>



Preview of : **Everest Nero**

BENEFITS OF  
PORCELAIN  
PAVERS

>

INDEX

>

PRODUCT  
RANGE

>

ACCESSORIES

>

TECHNICAL  
SPECIFICATIONS

>

# Slates Series

OUTDOOR PORCELAIN PAVERS

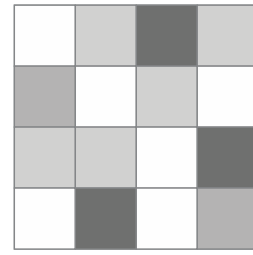

V4



R11

SURFACE

Sizes Available :



600x  
1200mm



600x  
900mm



800x  
800mm



600x  
600mm

Thickness

16mm

20mm

30mm



DIY



FROST  
RESISTANCE



STAIN  
RESISTANCE



1017

Random:  
Upto 8

African  
Slate

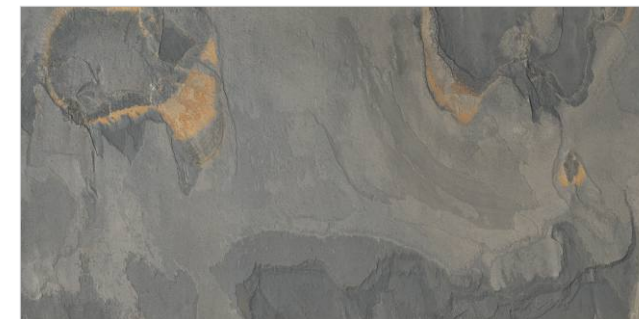

4223

Random:  
Upto 23

Grey  
Slate

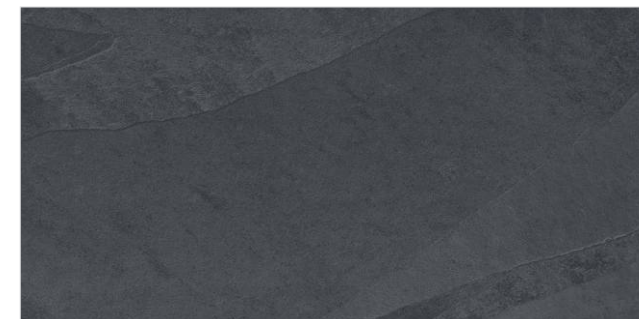

6122

Random:  
Upto 14

Black  
Slate



1223

Random:  
Upto 14

Casted  
Slate



3660

Random:  
Upto 29

Copper  
Slate



1183

Random:  
Upto 30

Rust  
Pennsylvania  
Bluestone

BENEFITS OF  
PORCELAIN  
PAVERS

>

INDEX

>

PRODUCT  
RANGE

>

ACCESSORIES

>

TECHNICAL  
SPECIFICATIONS

>



Preview of : **African Slate**

BENEFITS OF  
PORCELAIN  
PAVERS

>

INDEX

>

PRODUCT  
RANGE

>

ACCESSORIES

>

TECHNICAL  
SPECIFICATIONS

>



Preview of : **Casted Slate**

BENEFITS OF  
PORCELAIN  
PAVERS

>

INDEX

>

PRODUCT  
RANGE

>

ACCESSORIES

>

TECHNICAL  
SPECIFICATIONS

>



Preview of : **Grey Slate**

BENEFITS OF  
PORCELAIN  
PAVERS

>

INDEX

>

PRODUCT  
RANGE

>

ACCESSORIES

>

TECHNICAL  
SPECIFICATIONS

>



Preview of : **Copper Slate**

BENEFITS OF  
PORCELAIN  
PAVERS

>

INDEX

>

PRODUCT  
RANGE

>

ACCESSORIES

>

TECHNICAL  
SPECIFICATIONS

>

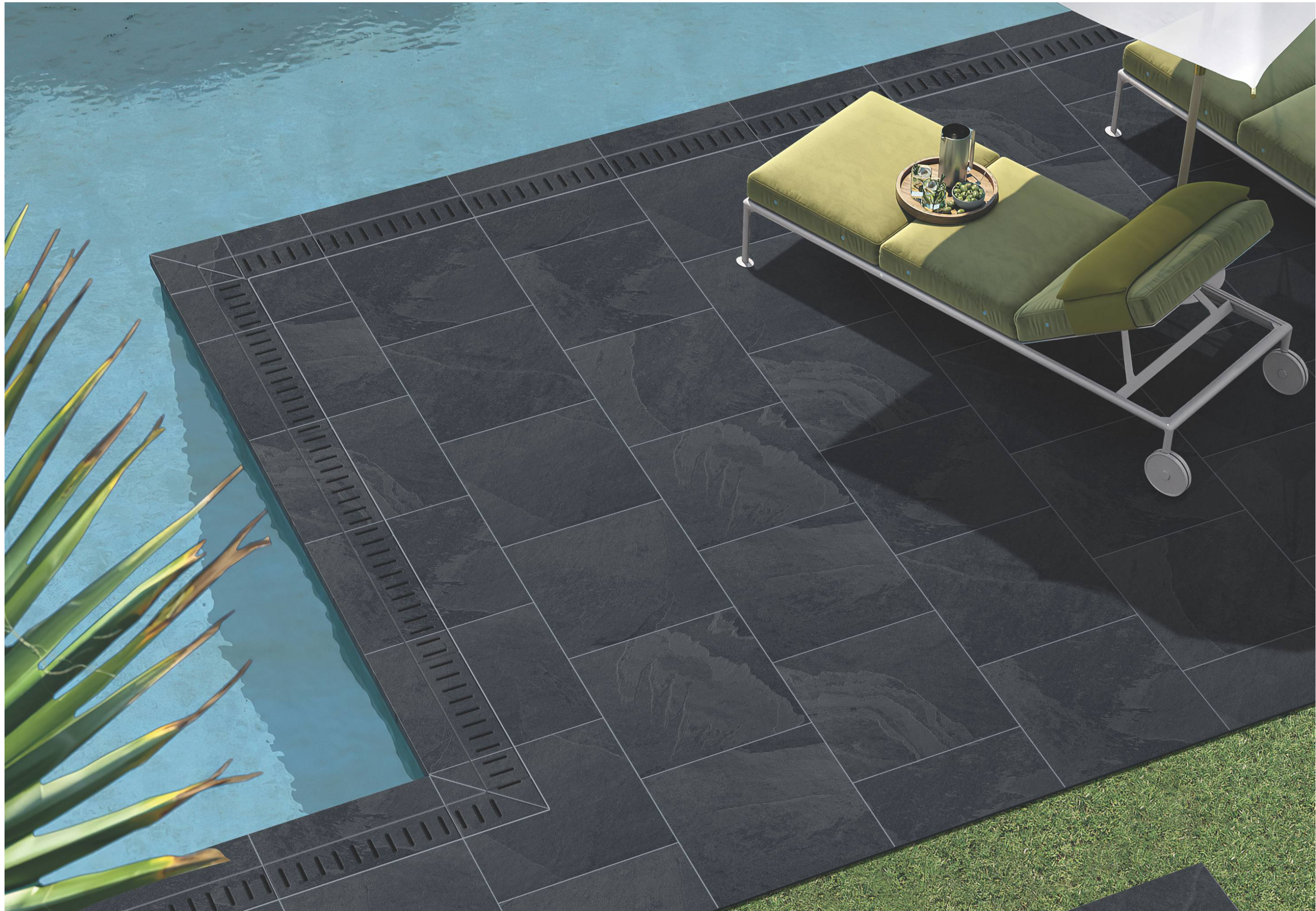

Preview of : **Black Slate**

BENEFITS OF  
PORCELAIN  
PAVERS

>

INDEX

>

PRODUCT  
RANGE

>

ACCESSORIES

>

TECHNICAL  
SPECIFICATIONS

>



Preview of : **Rust Pennsylvania Bluestone**

BENEFITS OF  
PORCELAIN  
PAVERS

>

INDEX

>

PRODUCT  
RANGE

>

ACCESSORIES

>

TECHNICAL  
SPECIFICATIONS

>

# Granites Series

OUTDOOR PORCELAIN PAVERS

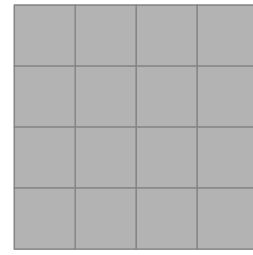

V1



R11

SURFACE

Sizes Available :



600x  
1200mm



600x  
900mm



800x  
800mm



600x  
600mm

Thickness

16mm

20mm

30mm



DIY



FROST  
RESISTANCE



STAIN  
RESISTANCE

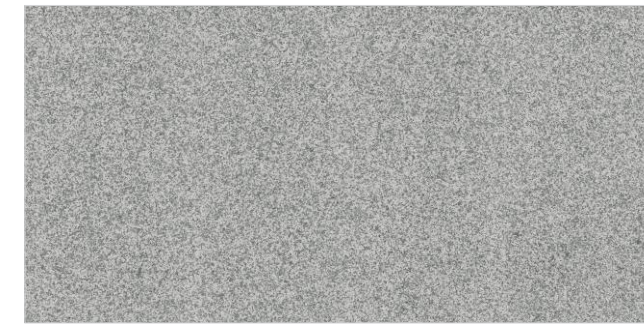

1027

Random : Upto 5

G-603



1026

Random : 1

G-654

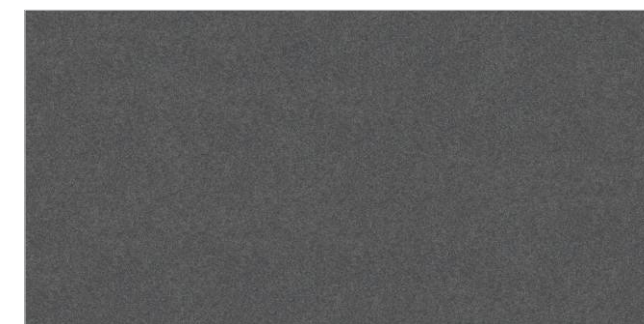

1098

Random : 1

Basalt

BENEFITS OF  
PORCELAIN  
PAVERS

>

INDEX

>

PRODUCT  
RANGE

>

ACCESSORIES

>

TECHNICAL  
SPECIFICATIONS

>



Preview of : **G-603**

BENEFITS OF  
PORCELAIN  
PAVERS

>

INDEX

>

PRODUCT  
RANGE

>

ACCESSORIES

>

TECHNICAL  
SPECIFICATIONS

>



Preview of : **G-654**

BENEFITS OF  
PORCELAIN  
PAVERS

>

INDEX

>

PRODUCT  
RANGE

>

ACCESSORIES

>

TECHNICAL  
SPECIFICATIONS

>

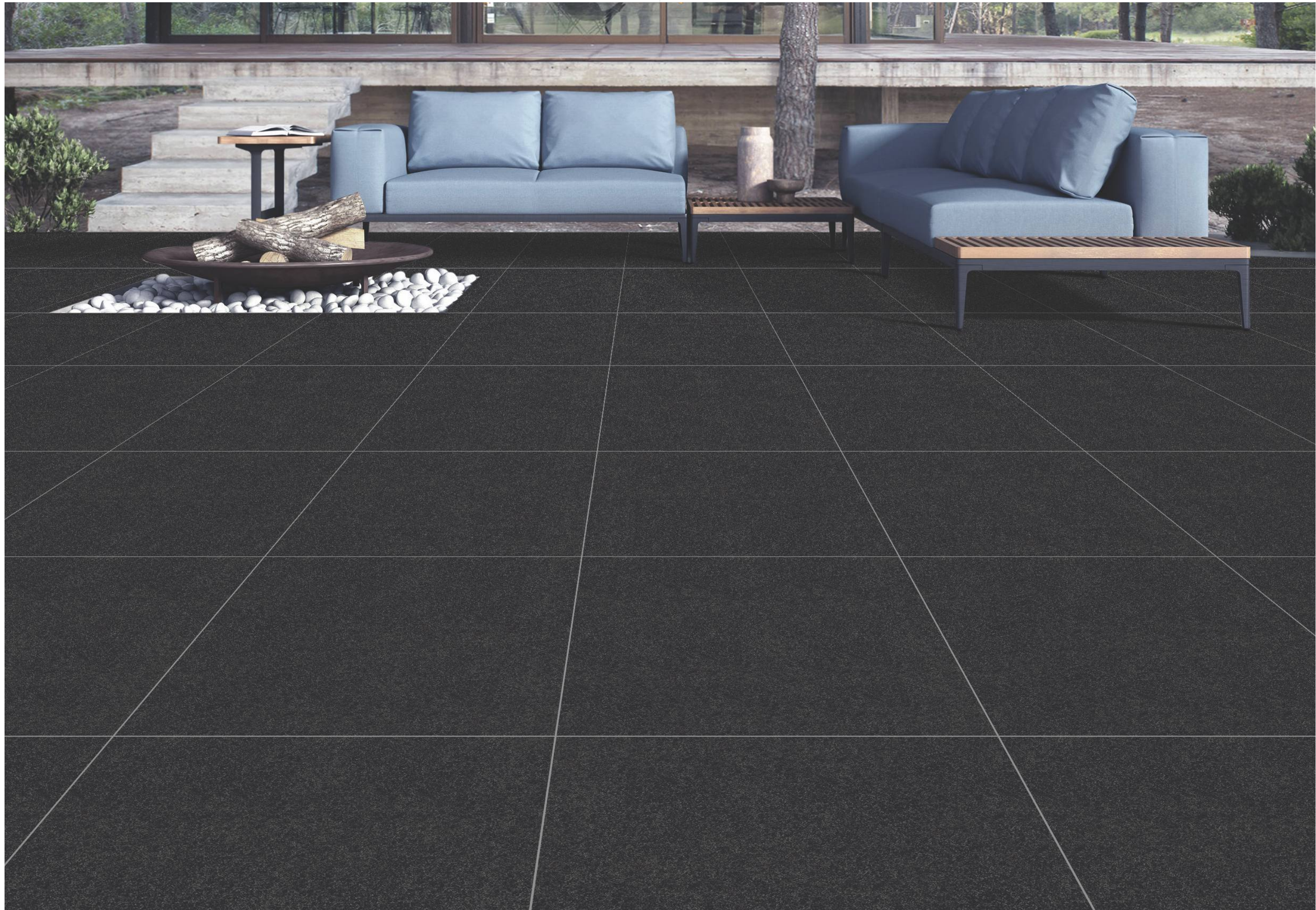

BENEFITS OF  
PORCELAIN  
PAVERS

>

INDEX

>

PRODUCT  
RANGE

>

ACCESSORIES

>

TECHNICAL  
SPECIFICATIONS

>

Preview of : **Basalt**

# Smoke Series

OUTDOOR PORCELAIN PAVERS

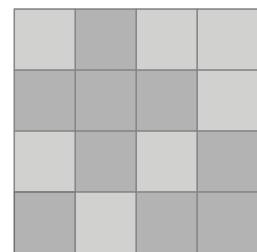

V2



**R11**  
SURFACE

Sizes Available :



**600x  
1200mm**

Random : 5



**600x  
900mm**

Random : 6



**800x  
800mm**

Random : 5



**600x  
600mm**

Random : 8

Thickness

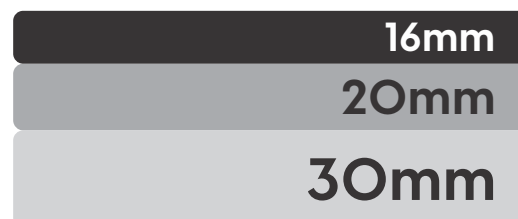

DIY



FROST  
RESISTANCE



STAIN  
RESISTANCE



**1391**

**Smoke Beige**



**1392**

**Smoke Taupe**

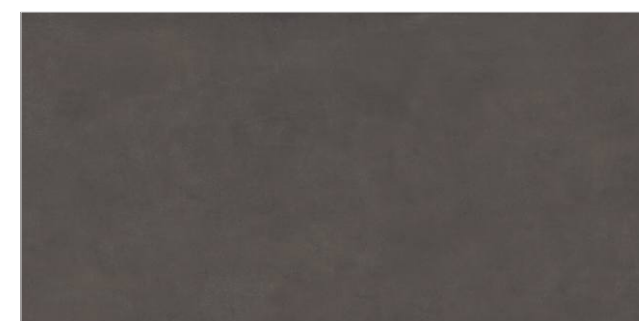

**1395**

**Smoke Tobac**

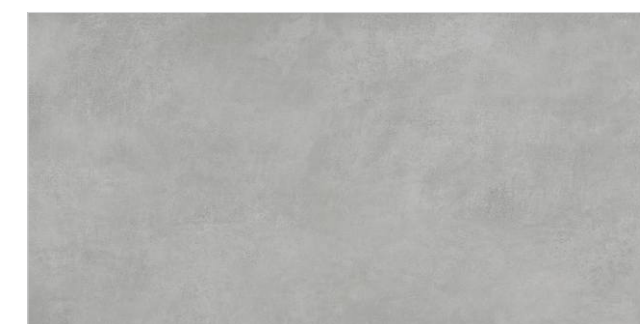

**1393**

**Smoke Sky**



**1394**

**Smoke Grey**



**1396**

**Smoke Nero**

BENEFITS OF  
PORCELAIN  
PAVERS

>

INDEX

>

PRODUCT  
RANGE

>

ACCESSORIES

>

TECHNICAL  
SPECIFICATIONS

>



Preview of : **Smoke Beige**

BENEFITS OF  
PORCELAIN  
PAVERS

>

INDEX

>

PRODUCT  
RANGE

>

ACCESSORIES

>

TECHNICAL  
SPECIFICATIONS

>



Preview of : **Smoke Taupe**

BENEFITS OF  
PORCELAIN  
PAVERS

>

INDEX

>

PRODUCT  
RANGE

>

ACCESSORIES

>

TECHNICAL  
SPECIFICATIONS

>



Preview of : **Smoke Tobac**

BENEFITS OF  
PORCELAIN  
PAVERS

>

INDEX

>

PRODUCT  
RANGE

>

ACCESSORIES

>

TECHNICAL  
SPECIFICATIONS

>



Preview of : **Smoke Sky**

BENEFITS OF  
PORCELAIN  
PAVERS

>

INDEX

>

PRODUCT  
RANGE

>

ACCESSORIES

>

TECHNICAL  
SPECIFICATIONS

>



Preview of : **Smoke Grey**

BENEFITS OF  
PORCELAIN  
PAVERS

>

INDEX

>

PRODUCT  
RANGE

>

ACCESSORIES

>

TECHNICAL  
SPECIFICATIONS

>



Preview of : **Smoke Nero**

BENEFITS OF  
PORCELAIN  
PAVERS

>

INDEX

>

PRODUCT  
RANGE

>

ACCESSORIES

>

TECHNICAL  
SPECIFICATIONS

>

# Sandstones Series

OUTDOOR PORCELAIN PAVERS

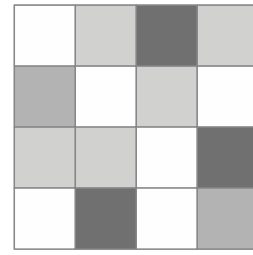

V4



R11

SURFACE

Sizes Available :



600x  
1200mm



600x  
900mm



800x  
800mm



600x  
600mm

Thickness

16mm

20mm

30mm



DIY



FROST  
RESISTANCE



STAIN  
RESISTANCE



1181 Random:  
Upto 60 Raveena



1085 Random:  
Upto 44 Raj  
Green



1090 Random:  
Upto 31 Sawn  
Buff



1086 Random:  
Upto 31 Cedar  
Green



1084 Random:  
Upto 20 York  
Stone



1083 Random:  
Upto 32 Buff

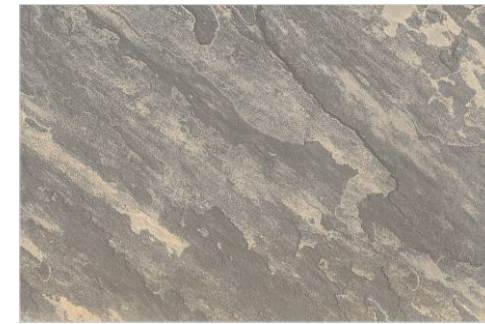

1081 Random:  
Upto 31 Sagar  
Black



1043 Random:  
Upto 68 Kandla  
Grey



1061 Random:  
Upto 8 Kandla  
Grey  
Honed

BENEFITS OF  
PORCELAIN  
PAVERS

>

INDEX

>

PRODUCT  
RANGE

>

ACCESSORIES

>

TECHNICAL  
SPECIFICATIONS

>



Preview of : **Raveena**

BENEFITS OF  
PORCELAIN  
PAVERS

>

INDEX

>

PRODUCT  
RANGE

>

ACCESSORIES

>

TECHNICAL  
SPECIFICATIONS

>



Preview of : **Raj Green**

BENEFITS OF  
PORCELAIN  
PAVERS

>

INDEX

>

PRODUCT  
RANGE

>

ACCESSORIES

>

TECHNICAL  
SPECIFICATIONS

>



Preview of : **Sawn Buff**

BENEFITS OF  
PORCELAIN  
PAVERS

>

INDEX

>

PRODUCT  
RANGE

>

ACCESSORIES

>

TECHNICAL  
SPECIFICATIONS

>



Preview of : **Cedar Green**

BENEFITS OF  
PORCELAIN  
PAVERS



INDEX



PRODUCT  
RANGE



ACCESSORIES



TECHNICAL  
SPECIFICATIONS





Preview of : **York Stone**

BENEFITS OF  
PORCELAIN  
PAVERS

>

INDEX

>

PRODUCT  
RANGE

>

ACCESSORIES

>

TECHNICAL  
SPECIFICATIONS

>



Preview of : **Buff**

BENEFITS OF  
PORCELAIN  
PAVERS

>

INDEX

>

PRODUCT  
RANGE

>

ACCESSORIES

>

TECHNICAL  
SPECIFICATIONS

>



Preview of : **Sagar Black**

BENEFITS OF  
PORCELAIN  
PAVERS

>

INDEX

>

PRODUCT  
RANGE

>

ACCESSORIES

>

TECHNICAL  
SPECIFICATIONS

>



Preview of : **Kandla Grey**

BENEFITS OF  
PORCELAIN  
PAVERS

>

INDEX

>

PRODUCT  
RANGE

>

ACCESSORIES

>

TECHNICAL  
SPECIFICATIONS

>

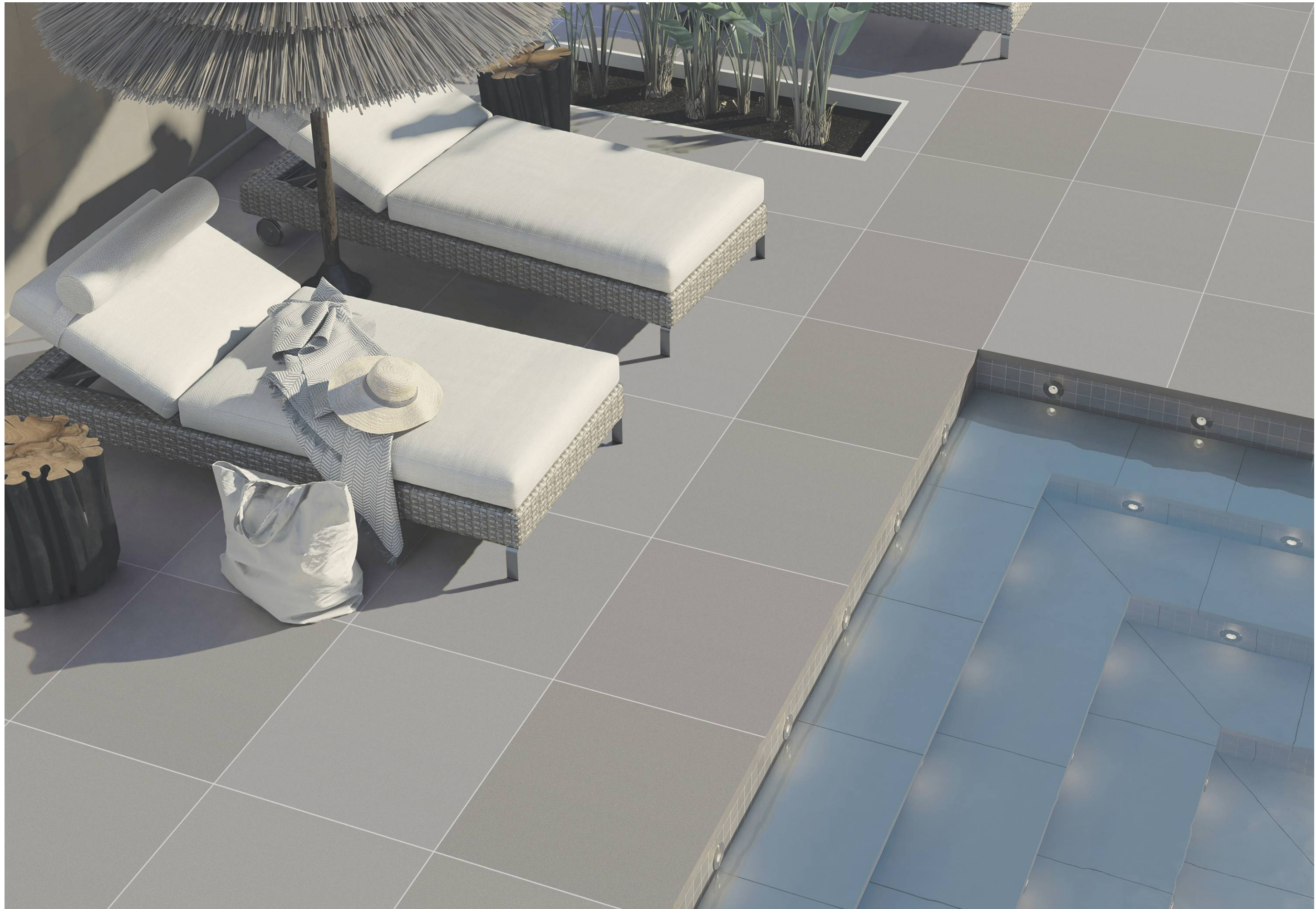

Preview of : **Kandla Grey Honed**

BENEFITS OF  
PORCELAIN  
PAVERS

>

INDEX

>

PRODUCT  
RANGE

>

ACCESSORIES

>

TECHNICAL  
SPECIFICATIONS

>

# Belgium Series

OUTDOOR PORCELAIN PAVERS

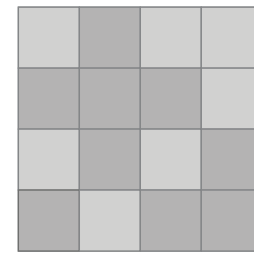

V2



**R11**

SURFACE

Sizes Available :



**600x  
1200mm**

Random : 8



**600x  
900mm**

Random : 16



**800x  
800mm**

Random : 16



**600x  
600mm**

Random : 16

Thickness

16mm

20mm

30mm



DIY



FROST  
RESISTANCE



STAIN  
RESISTANCE



**1247**

**Belgium Gris**



**1248**

**Belgium Grafito**



**1249**

**Belgium Nero**

BENEFITS OF  
PORCELAIN  
PAVERS

>

INDEX

>

PRODUCT  
RANGE

>

ACCESSORIES

>

TECHNICAL  
SPECIFICATIONS

>



Preview of : **Belgium Gris**

BENEFITS OF  
PORCELAIN  
PAVERS

>

INDEX

>

PRODUCT  
RANGE

>

ACCESSORIES

>

TECHNICAL  
SPECIFICATIONS

>



Preview of : **Belgium Grafito**

BENEFITS OF  
PORCELAIN  
PAVERS

>

INDEX

>

PRODUCT  
RANGE

>

ACCESSORIES

>

TECHNICAL  
SPECIFICATIONS

>



Preview of : **Belgium Nero**

BENEFITS OF  
PORCELAIN  
PAVERS

>

INDEX

>

PRODUCT  
RANGE

>

ACCESSORIES

>

TECHNICAL  
SPECIFICATIONS

>

# Bluestone Series

OUTDOOR PORCELAIN PAVERS

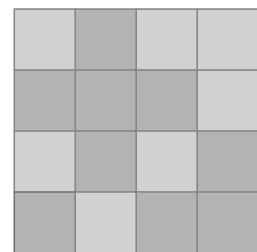

V2



R11

SURFACE

Sizes Available :



600x  
1200mm

Random : 2



600x  
900mm

Random : 3



800x  
800mm

Random : 3



600x  
600mm

Random : 4

Thickness

16mm

20mm

30mm



DIY



FROST  
RESISTANCE



STAIN  
RESISTANCE



7241 Bluestone Light



7242 Bluestone Dark

BENEFITS OF  
PORCELAIN  
PAVERS

>

INDEX

>

PRODUCT  
RANGE

>

ACCESSORIES

>

TECHNICAL  
SPECIFICATIONS

>



Preview of : **Bluestone Light**

BENEFITS OF  
PORCELAIN  
PAVERS

>

INDEX

>

PRODUCT  
RANGE

>

ACCESSORIES

>

TECHNICAL  
SPECIFICATIONS

>



Preview of : **Bluestone Dark**

BENEFITS OF  
PORCELAIN  
PAVERS

>

INDEX

>

PRODUCT  
RANGE

>

ACCESSORIES

>

TECHNICAL  
SPECIFICATIONS

>

# Marble Series

OUTDOOR PORCELAIN PAVERS

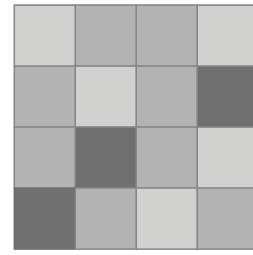

V3



R11

SURFACE

Sizes Available :



600x  
1200mm



600x  
900mm



800x  
800mm



600x  
600mm

Thickness

16mm

20mm

30mm



DIY



FROST  
RESISTANCE



STAIN  
RESISTANCE

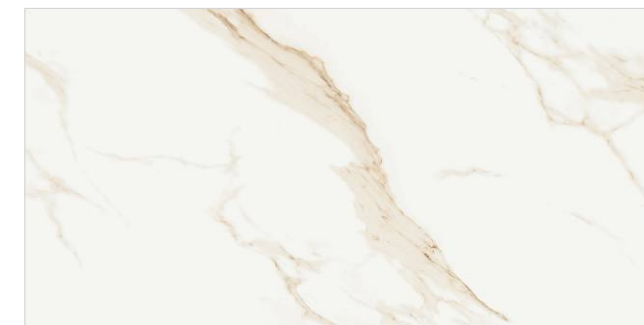

1454

Random: 6

Statuario  
Gold

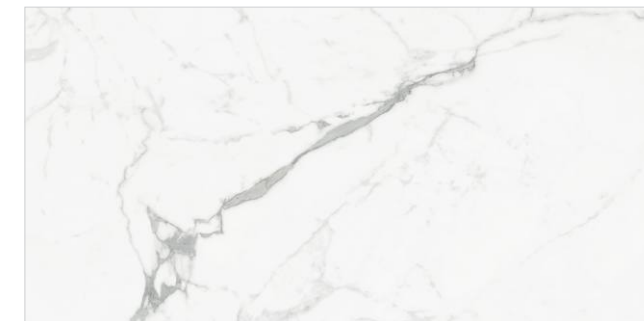

1451

Random: 12

Elegance  
Statuario

BENEFITS OF  
PORCELAIN  
PAVERS

>

INDEX

>

PRODUCT  
RANGE

>

ACCESSORIES

>

TECHNICAL  
SPECIFICATIONS

>

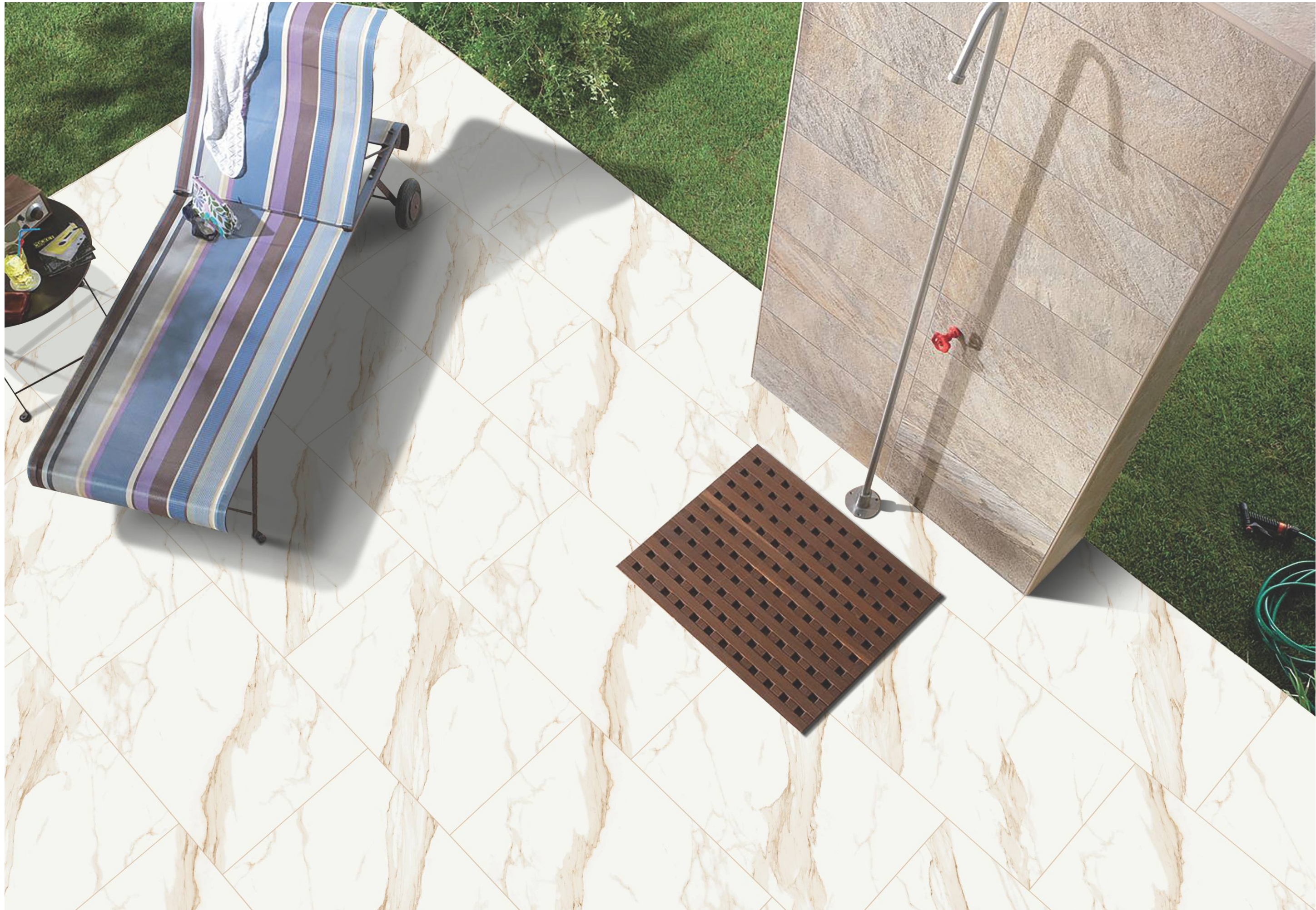

Preview of : **Statuario Gold**

BENEFITS OF  
PORCELAIN  
PAVERS

>

INDEX

>

PRODUCT  
RANGE

>

ACCESSORIES

>

TECHNICAL  
SPECIFICATIONS

>



Preview of : **Elegance Statuario**

BENEFITS OF  
PORCELAIN  
PAVERS

>

INDEX

>

PRODUCT  
RANGE

>

ACCESSORIES

>

TECHNICAL  
SPECIFICATIONS

>

# Wood Plank Series

OUTDOOR PORCELAIN PAVERS

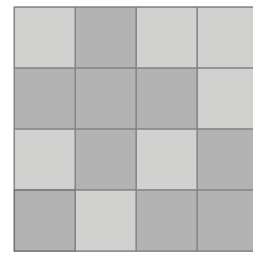

V2



**R11**  
SURFACE

Sizes Available :



**300x  
1200mm**

Random :  
Upto 12



**200x  
900mm**

Random :  
Upto 24

Thickness

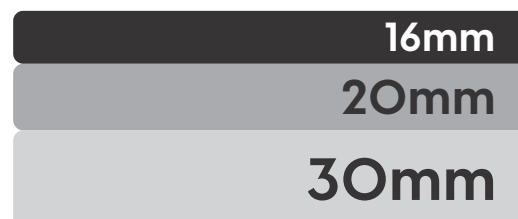

DIY



FROST  
RESISTANCE



STAIN  
RESISTANCE



1103 Wood Grove Beige



1104 Wood Grove Dark



1116 Wood Grove Light



1102 Wood Grove Grey



1133 Deckwood Amber



1134 Deckwood Caramel



1131 Deckwood Pearl



1136 Deckwood Charcoal

BENEFITS OF  
PORCELAIN  
PAVERS

>

INDEX

>

PRODUCT  
RANGE

>

ACCESSORIES

>

TECHNICAL  
SPECIFICATIONS

>



Preview of : **Wood Grove Beige**

BENEFITS OF  
PORCELAIN  
PAVERS

>

INDEX

>

PRODUCT  
RANGE

>

ACCESSORIES

>

TECHNICAL  
SPECIFICATIONS

>



Preview of : **Wood Grove Dark**

BENEFITS OF  
PORCELAIN  
PAVERS

>

INDEX

>

PRODUCT  
RANGE

>

ACCESSORIES

>

TECHNICAL  
SPECIFICATIONS

>



Preview of : **Wood Grove Light**

BENEFITS OF  
PORCELAIN  
PAVERS

>

INDEX

>

PRODUCT  
RANGE

>

ACCESSORIES

>

TECHNICAL  
SPECIFICATIONS

>



Preview of : **Wood Grove Grey**

BENEFITS OF  
PORCELAIN  
PAVERS

>

INDEX

>

PRODUCT  
RANGE

>

ACCESSORIES

>

TECHNICAL  
SPECIFICATIONS

>



Preview of : **Deckwood Amber**

BENEFITS OF  
PORCELAIN  
PAVERS

>

INDEX

>

PRODUCT  
RANGE

>

ACCESSORIES

>

TECHNICAL  
SPECIFICATIONS

>



Preview of : **Deckwood Caramel**

BENEFITS OF  
PORCELAIN  
PAVERS

>

INDEX

>

PRODUCT  
RANGE

>

ACCESSORIES

>

TECHNICAL  
SPECIFICATIONS

>



Preview of : **Deckwood Pearl**

BENEFITS OF  
PORCELAIN  
PAVERS

>

INDEX

>

PRODUCT  
RANGE

>

ACCESSORIES

>

TECHNICAL  
SPECIFICATIONS

>



Preview of : **Deckwood Charcoal**

BENEFITS OF  
PORCELAIN  
PAVERS

>

INDEX

>

PRODUCT  
RANGE

>

ACCESSORIES

>

TECHNICAL  
SPECIFICATIONS

>

# Accessories

OUTDOOR PORCELAIN PAVERS

## 1. Cobbles

Sizes Available :



100x  
100mm



100x  
200mm

## 2. Step-Riser

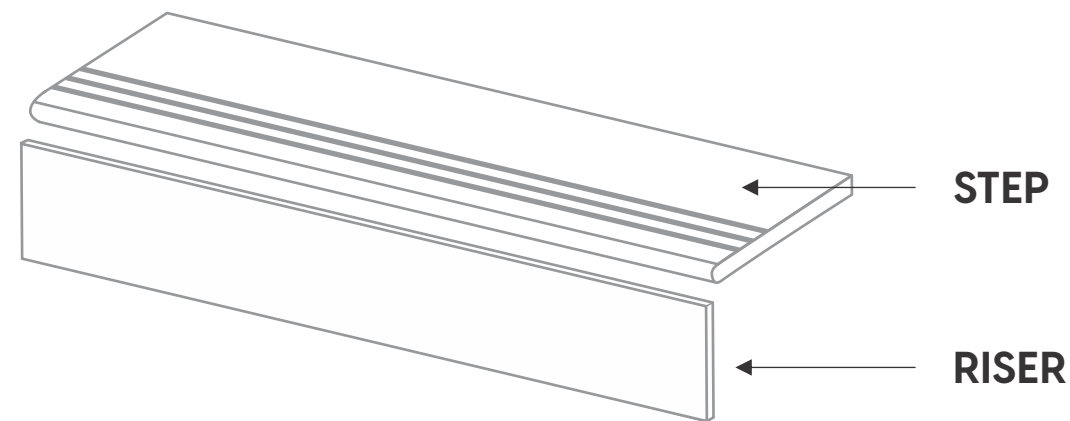

Sizes Available :

STEP

450x1200mm  
450x900mm  
300x1200mm  
300x900mm

RISER

150x1200mm  
150x900mm  
200x1200mm  
200x900mm



Half Bullnose



Full Bullnose

## 3. Edging

Size Available :



200x  
900mm

## 4. Coping

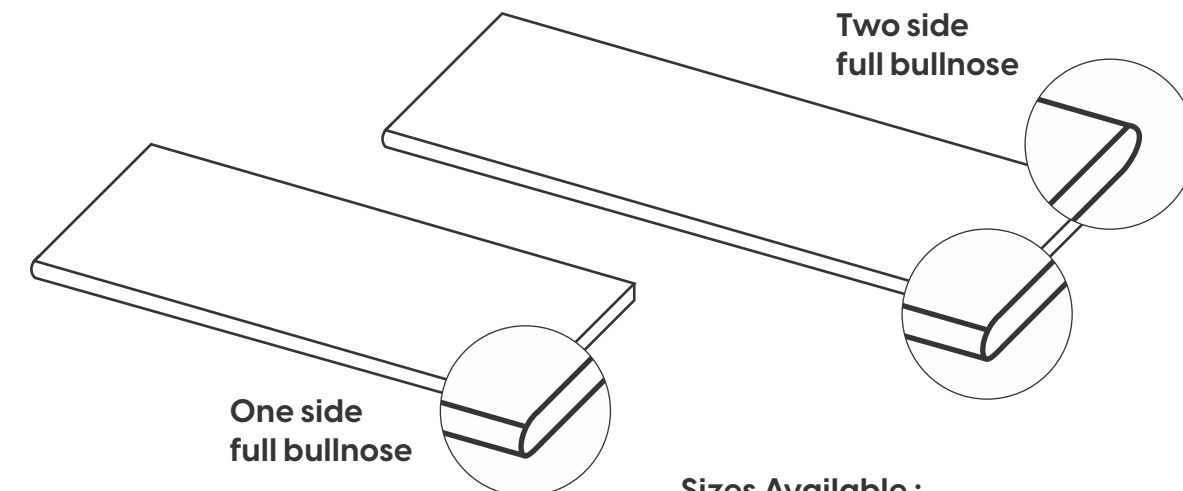

Sizes Available :

300x900mm  
300x1200mm

## 5. Pool Drains

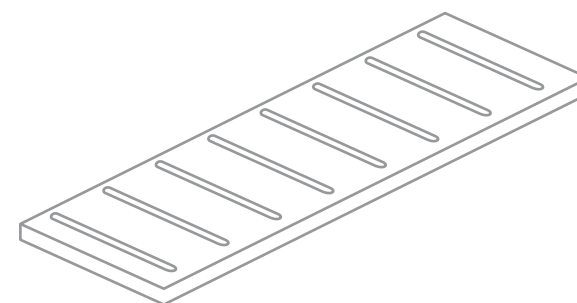

Sizes Available :

200x600mm  
200x900mm

BENEFITS OF  
PORCELAIN  
PAVERS

>

INDEX

>

PRODUCT  
RANGE

>

ACCESSORIES

>

TECHNICAL  
SPECIFICATIONS

>

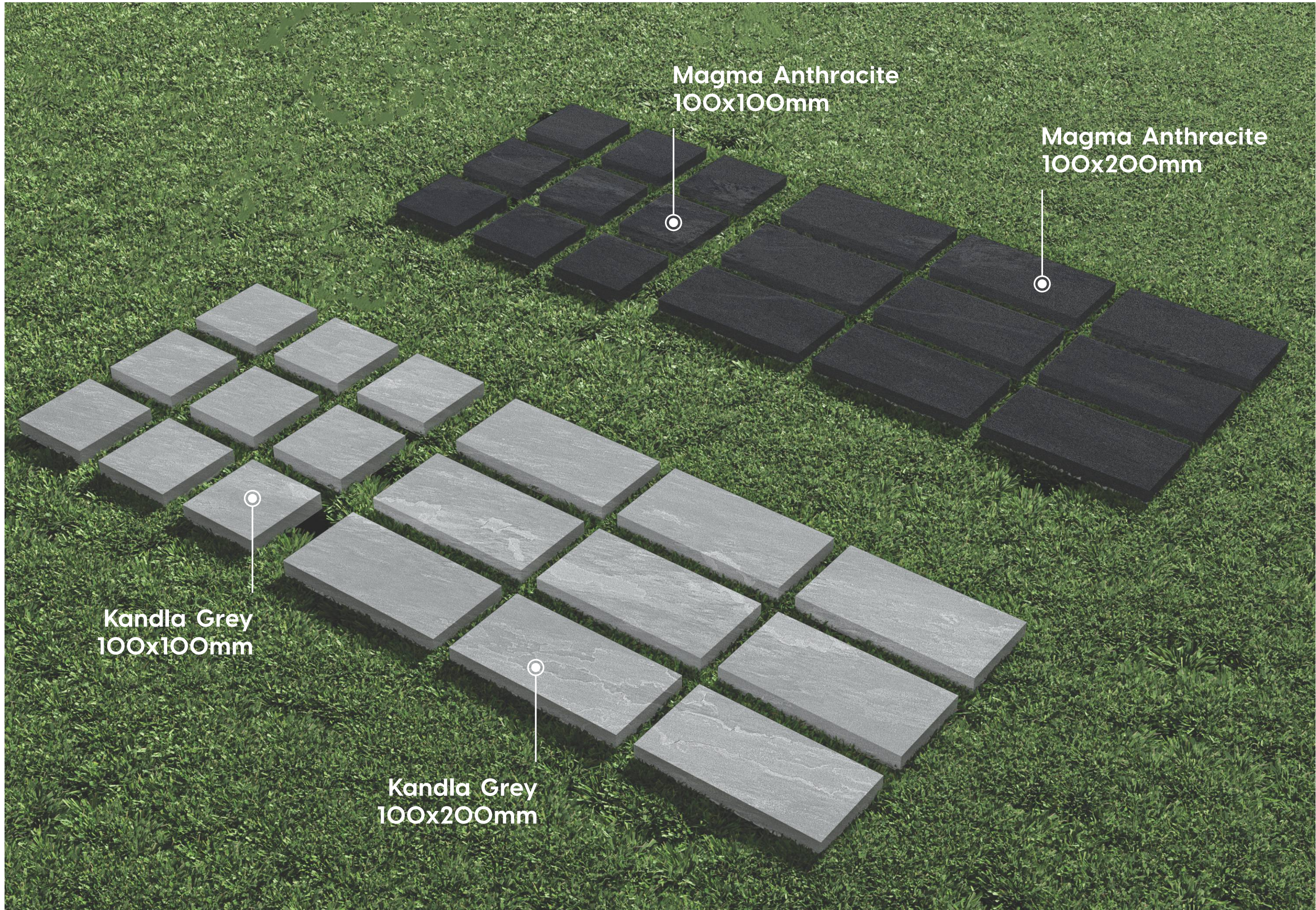

Magma Anthracite  
100x100mm

Magma Anthracite  
100x200mm

Kandla Grey  
100x100mm

Kandla Grey  
100x200mm

Preview of : **Cobbles**

BENEFITS OF  
PORCELAIN  
PAVERS

>

INDEX

>

PRODUCT  
RANGE

>

ACCESSORIES

>

TECHNICAL  
SPECIFICATIONS

>



Crystal Bianco  
150x1200mm (Riser)

Crystal Bianco  
450x1200mm (Step)

Preview of : **Step-Riser**

BENEFITS OF  
PORCELAIN  
PAVERS

>

INDEX

>

PRODUCT  
RANGE

>

ACCESSORIES

>

TECHNICAL  
SPECIFICATIONS

>



Kandla Grey  
150x1200mm (Riser)

Kandla Grey  
450x1200mm (Step)

Preview of : **Step-Riser**

BENEFITS OF  
PORCELAIN  
PAVERS

>

INDEX

>

PRODUCT  
RANGE

>

ACCESSORIES

>

TECHNICAL  
SPECIFICATIONS

>



Earthstone Grey  
150x900mm (Riser)

Earthstone Grey  
450x900mm (Step)

Preview of : **Step-Riser**

BENEFITS OF  
PORCELAIN  
PAVERS

>

INDEX

>

PRODUCT  
RANGE

>

ACCESSORIES

>

TECHNICAL  
SPECIFICATIONS

>

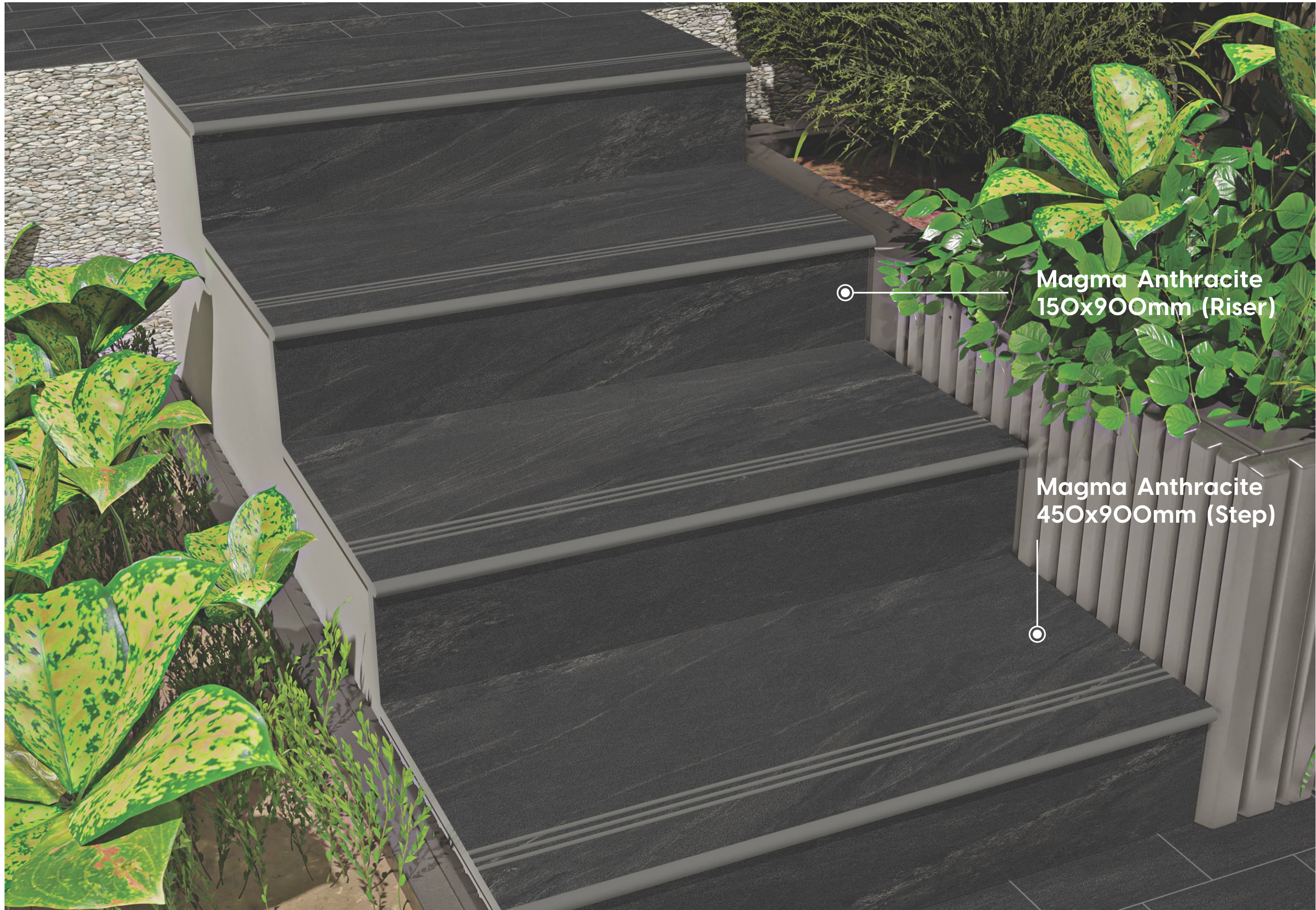

Magma Anthracite  
150x900mm (Riser)

Magma Anthracite  
450x900mm (Step)

Preview of : **Step-Riser**

BENEFITS OF  
PORCELAIN  
PAVERS

>

INDEX

>

PRODUCT  
RANGE

>

ACCESSORIES

>

TECHNICAL  
SPECIFICATIONS

>

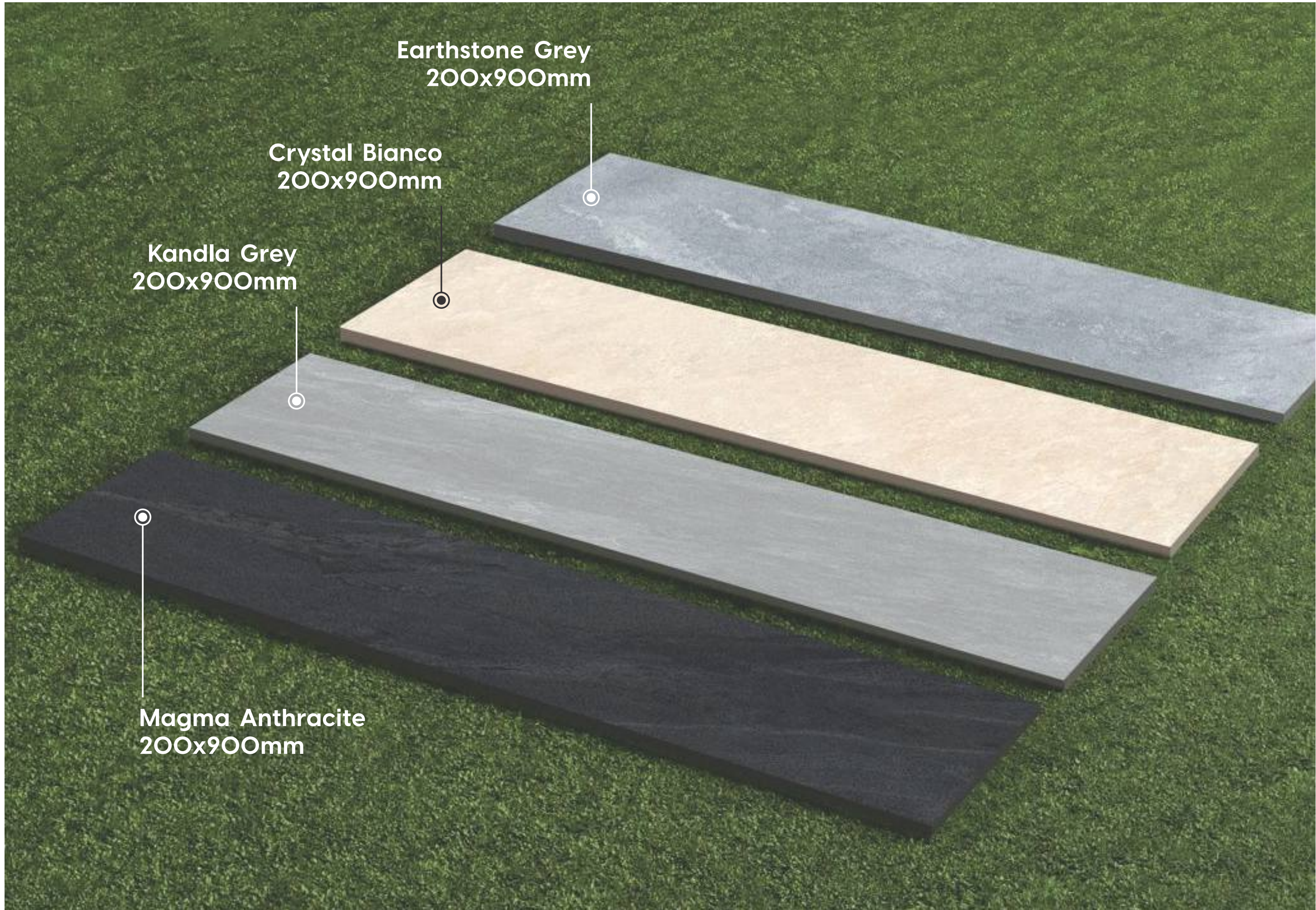

Earthstone Grey  
200x900mm

Crystal Bianco  
200x900mm

Kandla Grey  
200x900mm

Magma Anthracite  
200x900mm

Preview of : **Edging**

BENEFITS OF  
PORCELAIN  
PAVERS

>

INDEX

>

PRODUCT  
RANGE

>

ACCESSORIES

>

TECHNICAL  
SPECIFICATIONS

>



**Quartzite Pearl  
300x1200mm  
(Two Side Full Bullnose)**

Preview of : **Coping**

BENEFITS OF  
PORCELAIN  
PAVERS

>

INDEX

>

PRODUCT  
RANGE

>

ACCESSORIES

>

TECHNICAL  
SPECIFICATIONS

>

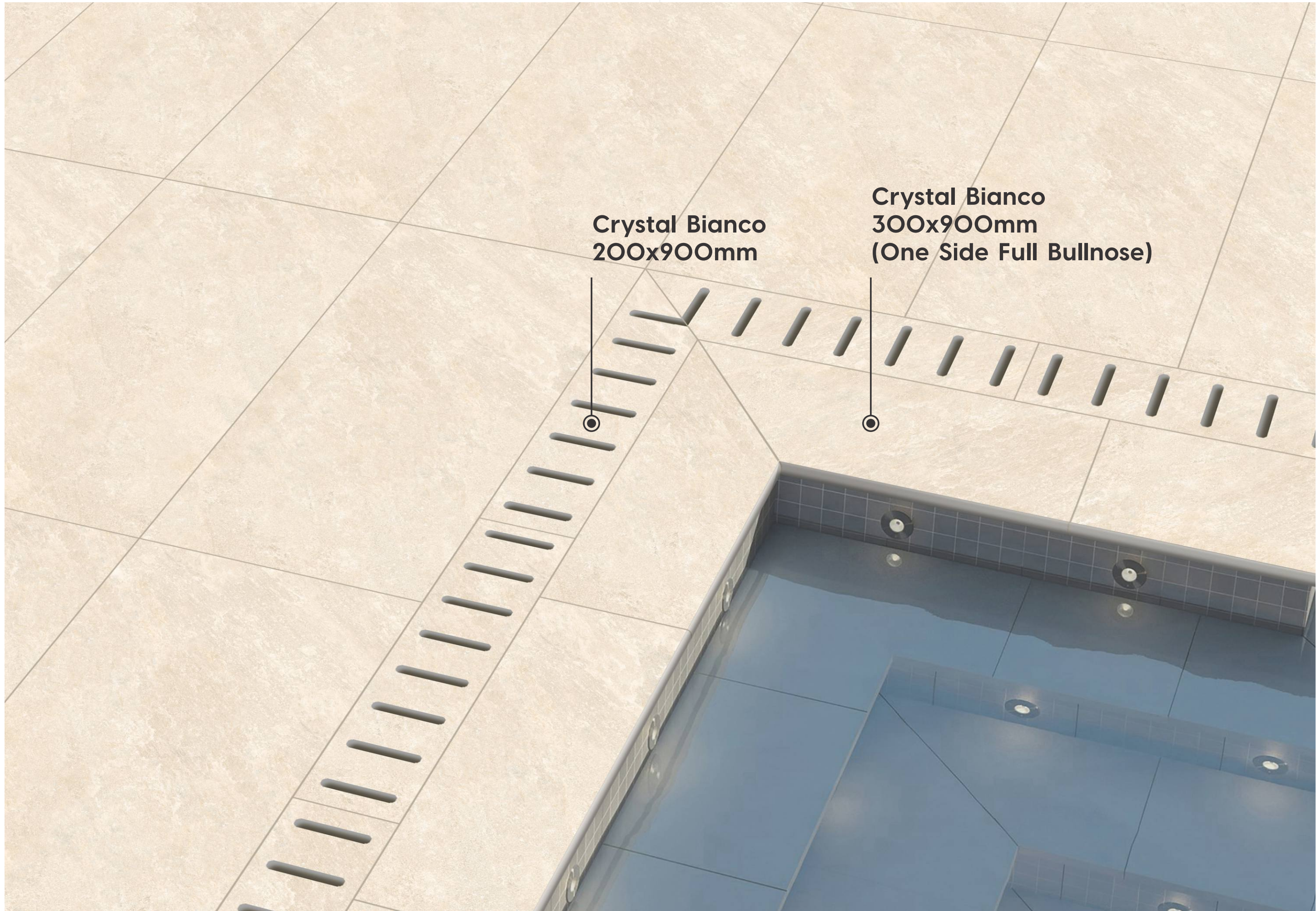

**Crystal Bianco  
200x900mm**

**Crystal Bianco  
300x900mm  
(One Side Full Bullnose)**

Preview of : **Coping & Pool Drains**

BENEFITS OF  
PORCELAIN  
PAVERS

>

INDEX

>

PRODUCT  
RANGE

>

ACCESSORIES

>

TECHNICAL  
SPECIFICATIONS

>

# Technical Specifications

600x1200x20mm OUTDOOR PORCELAIN PAVERS

TEST DESCRIPTION	STANDARD TEST METHOD	STANDARD REQUIREMENTS	OUR SPECIFICATIONS FOR PRODUCTION
LENGH	BS EN ISO 10545-2	±0.60%	±0.07% (±0.8MM)
WIDTH	BS EN ISO 10545-2	±0.60%	±0.07%(±0.4MM)
THICKNESS	BS EN ISO 10545-2	±5%	±2.5%(0.5MM)
STRAIGHTNESS OF SIDES	BS EN ISO 10545-2	±0.5%	±0.06%(±0.4MM)
RECTANGULARITY	BS EN ISO 10545-2	±0.5%	±0.12%
"SURFACE FLATNESS: CENTRE CURVATURE"	BS EN ISO 10545-2	±0.5%	±0.15%(+1.0MM) ±0.07%(-0.5 MM)
"SURFACE FLATNESS :WARPAGE"	BS EN ISO 10545-2	±0.5%	+0.17% (+1.0MM) +0.08%(+0.5MM)
"SURFACE FLATNESS :WARPAGE"	BS EN ISO 10545-2	±0.5%	-0.15%(1.0MM) -0.07%(-0.5 MM)
WATER ABSORPTION	BS EN ISO 10545-3	E ≤ 0.5%	E ≤ 0.4%
BREAKING STRENGTH	BS EN ISO 10545-4	≥ 1300 N	≥ 10600 N
MODULUS OF RUPTURE	BS EN ISO 10545-4	≥ 35 N/MM <sup>2</sup>	≥ 45 N/MM <sup>2</sup>
"RESISTANCE OF SURFACE ABRASION"	BS EN ISO 10545-7	"MANUFACTURE TO STATE ABRASION CLASS"	CLASS -IV
"COEFFICIENT OF LINER THERMAL EXPANSION"	BS EN ISO 10545-8	9x10 <sup>-6</sup> K <sup>-1</sup> MAX	≤ 4x10 <sup>-6</sup> K <sup>-1</sup> MAX
RESISTANCE THERMAL SHOCK	BS EN ISO 10545-9	MINI 10 CYCLES	FULLY RESISTANCE
CRAZING RESISTANCE	BS EN ISO 10545-11	"PASS ACCORDING TO EN ISO 10545-1g TWO CYCLE MUST PASS"	FULLY RESISTANCE
"RESISTANCE TO HOUSE HOLD CHEMICALS & SWIMMING POOL SALTS	BS EN ISO 10545-13	MINIMUM CLASS GC	CLASS GA
"RESISTANCE TO LOW CONCENTRATIONS ACIDS & ALKALIS"	BS EN ISO 10545-13	MINIMUM CLASS GLC	CLASS GLA
RESISTANCE TO STAINS	BS EN ISO 10545-14	MINIMUM CLASS 3	CLASS 4

# Technical Specifications

600x900x20mm OUTDOOR PORCELAIN PAVERS

TEST DESCRIPTION	STANDARD TEST METHOD	STANDARD REQUIREMENTS	OUR SPECIFICATIONS FOR PRODUCTION
LENGH	BS EN ISO 10545-2	±0.60%	±0.07% (±0.4MM)
WIDTH	BS EN ISO 10545-2	±0.60%	±0.07%(±0.6MM)
THICKNESS	BS EN ISO 10545-2	±5%	±2.5%(0.5MM)
STRAIGHTNESS OF SIDES	BS EN ISO 10545-2	±0.5%	±0.06%(±0.4MM)
RECTANGULARITY	BS EN ISO 10545-2	±0.5%	±0.12%
"SURFACE FLATNESS: CENTRE CURVATURE"	BS EN ISO 10545-2	±0.5%	±0.15%(+1.0MM) ±0.07%(-0.5 MM)
"SURFACE FLATNESS :WARPAGE"	BS EN ISO 10545-2	±0.5%	+0.17% (+1.0MM) +0.08%(+0.5MM)
"SURFACE FLATNESS :WARPAGE"	BS EN ISO 10545-2	±0.5%	-0.15%(1.0MM) -0.07%(-0.5 MM)
WATER ABSORPTION	BS EN ISO 10545-3	E ≤ 0.5%	E ≤ 0.4%
BREAKING STRENGTH	BS EN ISO 10545-4	≥ 1300 N	≥ 10600 N
MODULUS OF RUPTURE	BS EN ISO 10545-4	≥ 35 N/MM <sup>2</sup>	≥ 45 N/MM <sup>2</sup>
"RESISTANCE OF SURFACE ABRASION"	BS EN ISO 10545-7	"MANUFACTURE TO STATE ABRASION CLASS"	CLASS -IV
"COEFFICIENT OF LINER THERMAL EXPANSION"	BS EN ISO 10545-8	9x10 <sup>-6</sup> K <sup>-1</sup> MAX	≤ 4x10 <sup>-6</sup> K <sup>-1</sup> MAX
RESISTANCE THERMAL SHOCK	BS EN ISO 10545-9	MINI 10 CYCLES	FULLY RESISTANCE
CRAZING RESISTANCE	BS EN ISO 10545-11	"PASS ACCORDING TO EN ISO 10545-1g TWO CYCLE MUST PASS"	FULLY RESISTANCE
"RESISTANCE TO HOUSE HOLD CHEMICALS & SWIMMING POOL SALTS	BS EN ISO 10545-13	MINIMUM CLASS GC	CLASS GA
"RESISTANCE TO LOW CONCENTRATIONS ACIDS & ALKALIS"	BS EN ISO 10545-13	MINIMUM CLASS GLC	CLASS GLA
RESISTANCE TO STAINS	BS EN ISO 10545-14	MINIMUM CLASS 3	CLASS 4

BENEFITS OF PORCELAIN PAVERS

>

INDEX

>

PRODUCT RANGE

>

ACCESSORIES

>

TECHNICAL SPECIFICATIONS

>

**THANK YOU!**